

... more data!

Internet developments

Google

DATA

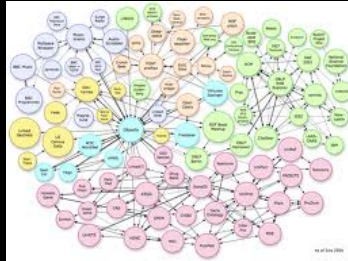
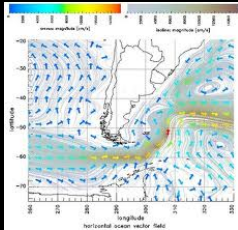

... more realtime!



twitter



myspace
a place for freedom



Linked in



SchoolBANK

Hyves

flickr
from YAHOO!



... more users!



... more data!

Internet developments

Google

Speed
Volume

DATA

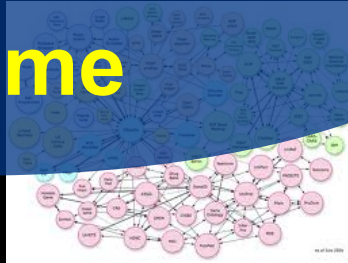
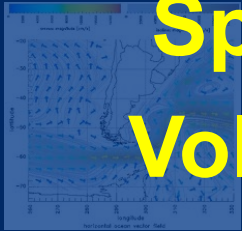

Deterministic

Real-time



twitter



Scalable

Secure

Linked in



myspace
SchoolBANK

Hyves

flickr
from YAHOO!



... more users!



From King's Dutch Academy of Sciences The Dutch Research Agenda

“Information technology (IT) now permeates all aspects of public, commercial, social, and personal life. bank cards, satnav, and weather radar... IT has become completely indispensable.”

“But to **guarantee** the **reliability** and **quality** of constantly **bigger** and more **complicated** IT, we will need to find answers to some **fundamental questions!**”



Mission

Can we create smart and safe data processing infrastructures that can be tailored to diverse application needs?

- *Capacity*
- *Capability*
- *Security*
- *Sustainability*
- *Resilience*

Mission

Can we create smart and safe data processing infrastructures that can be tailored to diverse application needs?

- *Capacity*
 - *Bandwidth on demand, QoS, architectures, photonics, performance*
- *Capability*
 - *Programmability, virtualization, complexity, semantics, workflows*
- *Security*
 - *Anonymity, integrity of data in distributed data processing*
- *Sustainability*
 - *Greening infrastructure, awareness*
- *Resilience*
 - *Systems under attack, failures, disasters*



Mission

Can we create smart and safe data processing infrastructures that can be tailored to diverse application needs?

- **Capacity**
 - *Bandwidth on demand, QoS, architectures, photonics, performance*
- **Capability**
 - *Programmability, virtualization, complexity, semantics, workflows*
- **Security**
 - *Anonymity, integrity of data in distributed data processing*
- **Sustainability**
 - *Greening infrastructure, awareness*
- **Resilience**
 - *Systems under attack, failures, disasters*



ATLAS detector @ CERN Geneve

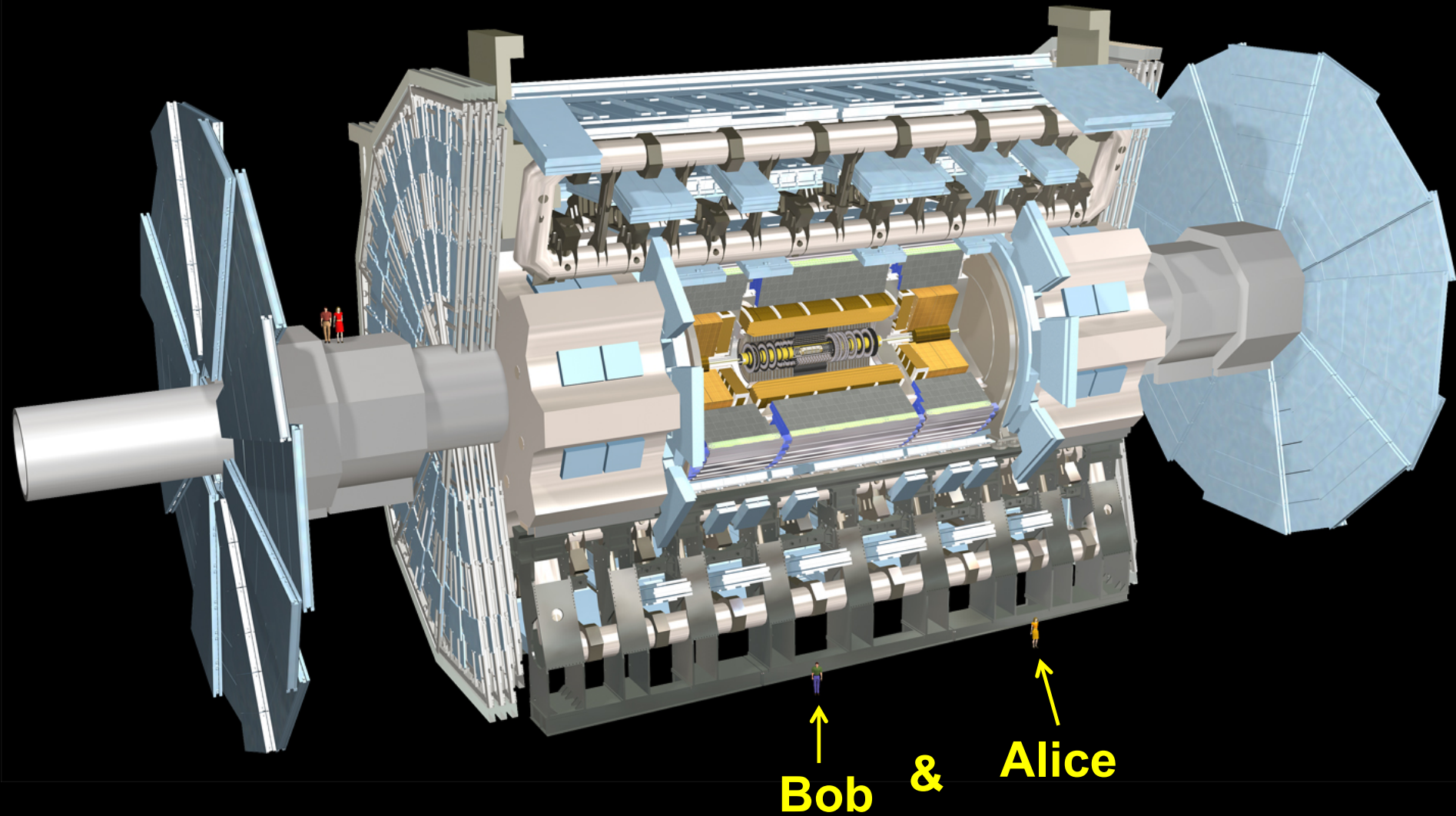

What Happens in an Internet Minute?



And Future Growth is Staggering



There
is
always
a
bigger
fish

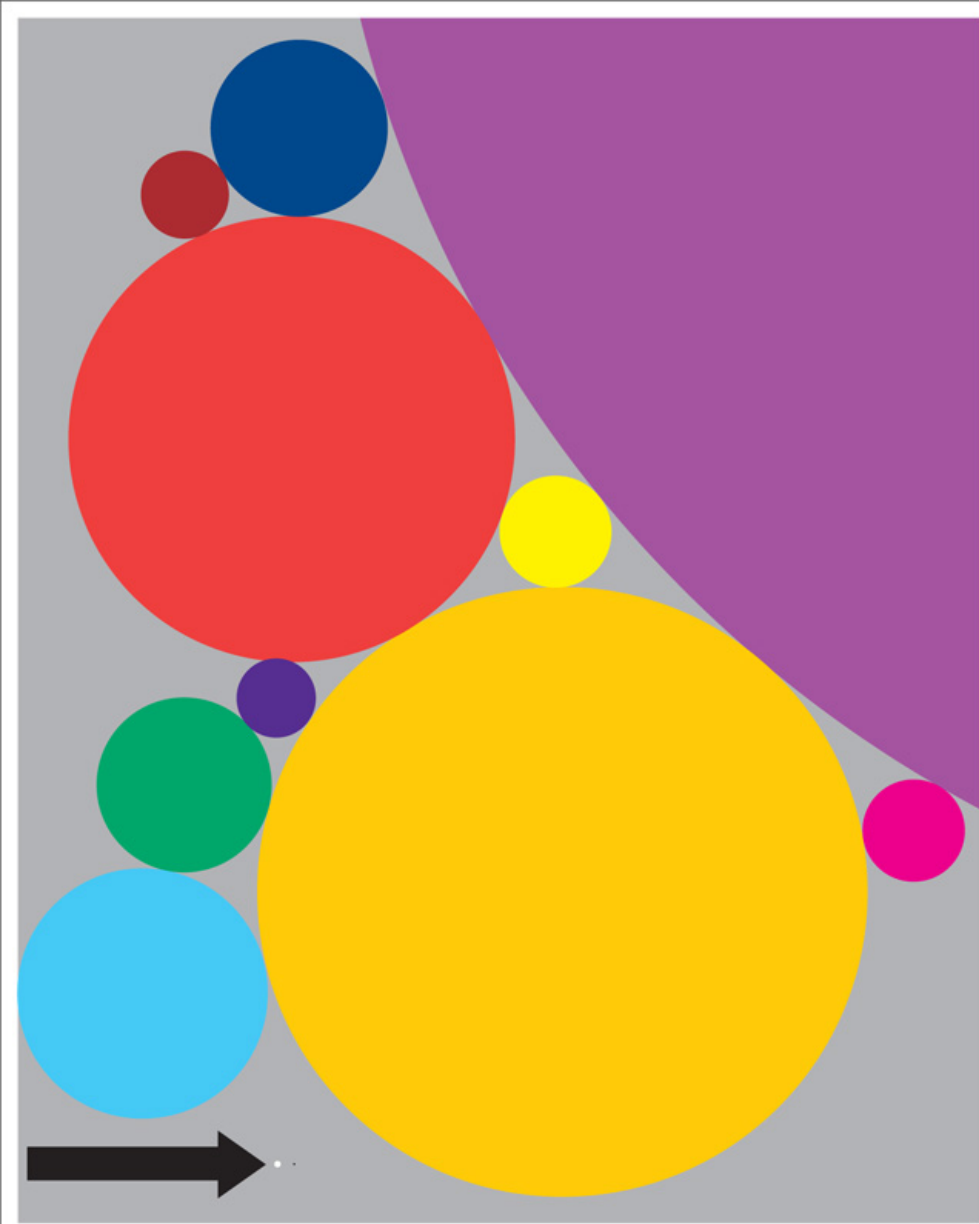

Size of data sets in terabytes

Business email sent per year	2,986,100	National Climactic Data Center database	6,144
Content uploaded to Facebook each year	182,500	Library of Congress' digital collection	5,120
Google's search index	97,656	US Census Bureau data	3,789
Kaiser Permanente's digital health records	30,720	Nasdaq stock market database	3,072
Large Hadron Collider's annual data output	15,360	Tweets sent in 2012	19
Videos uploaded to YouTube per year	15,000	Contents of every print issue of WIRED	1.26

GPU cards are disruptive!

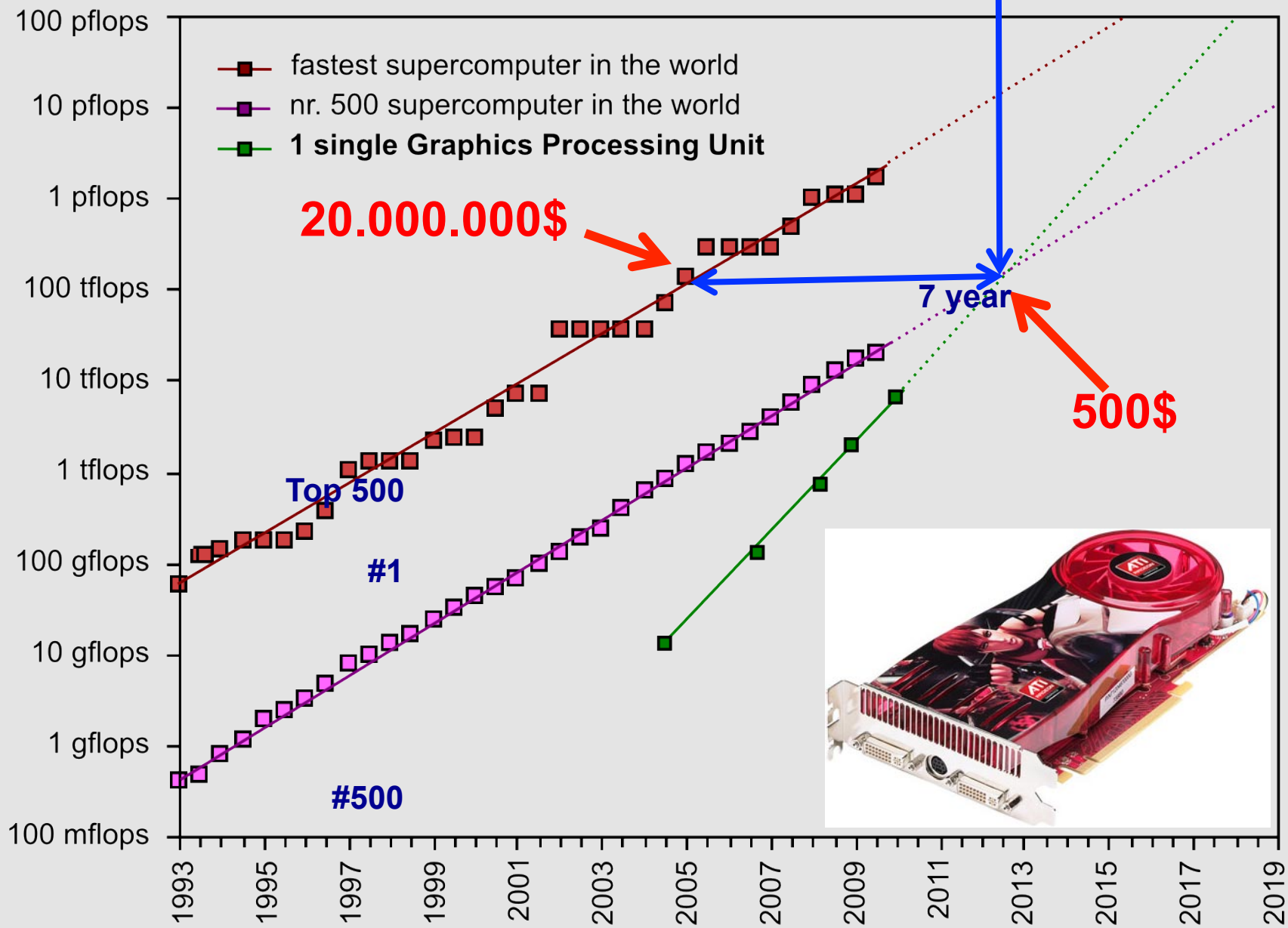

Multiple colors / Fiber

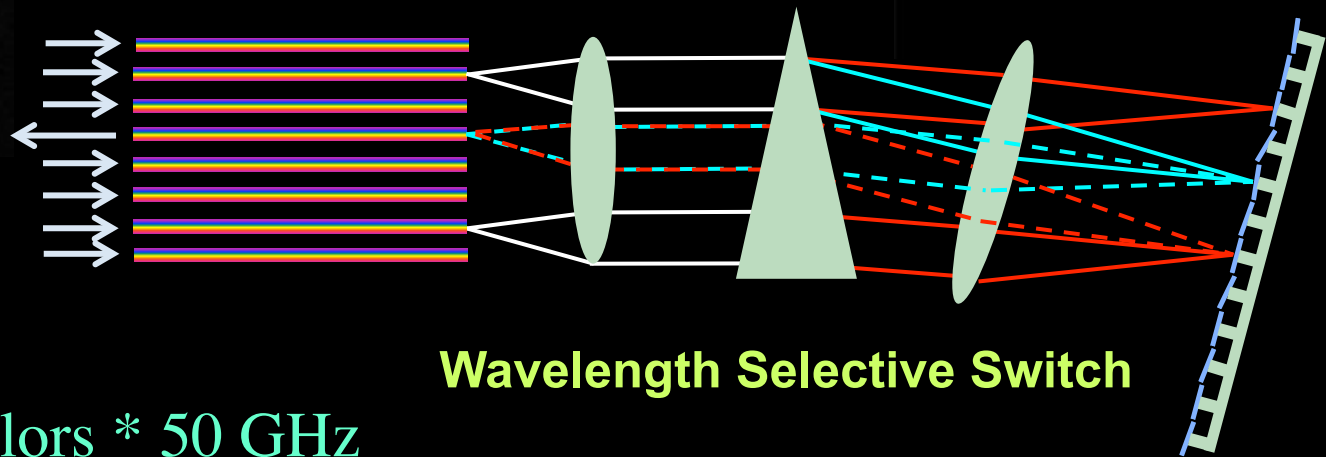
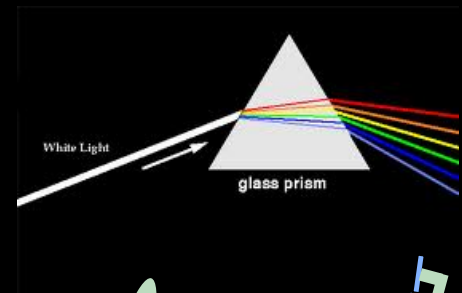
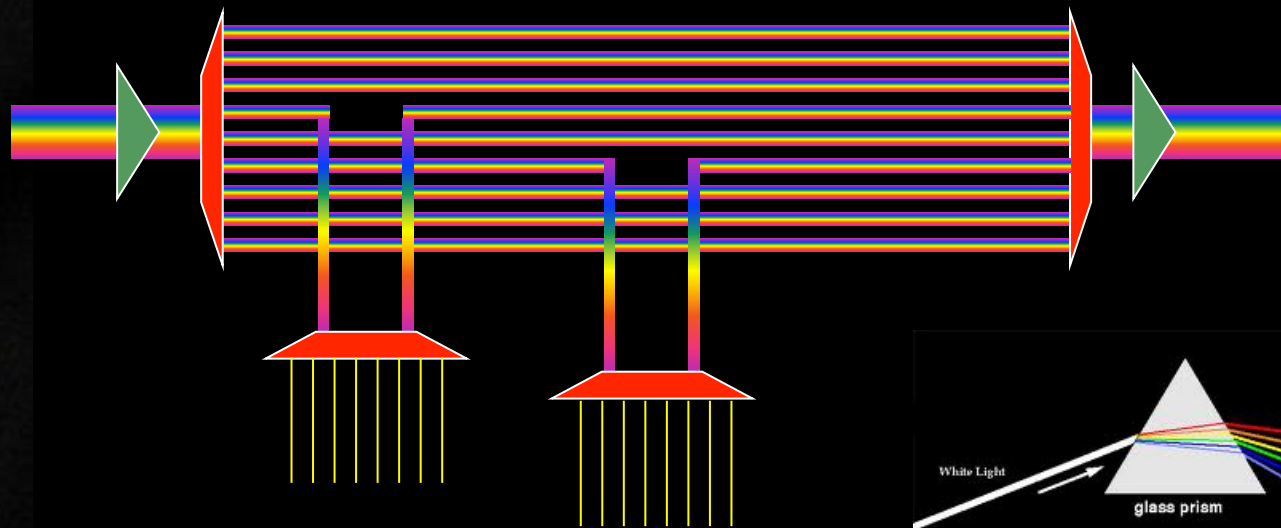

Wavelength Selective Switch

Per fiber: $\sim 80-100$ colors * 50 GHz

Per color: 10 – 40 – 100 Gbit/s

BW * Distance $\sim 2 * 10^{17}$ bm/s

New: Hollow Fiber!

→ less RTT!



Wireless Networks

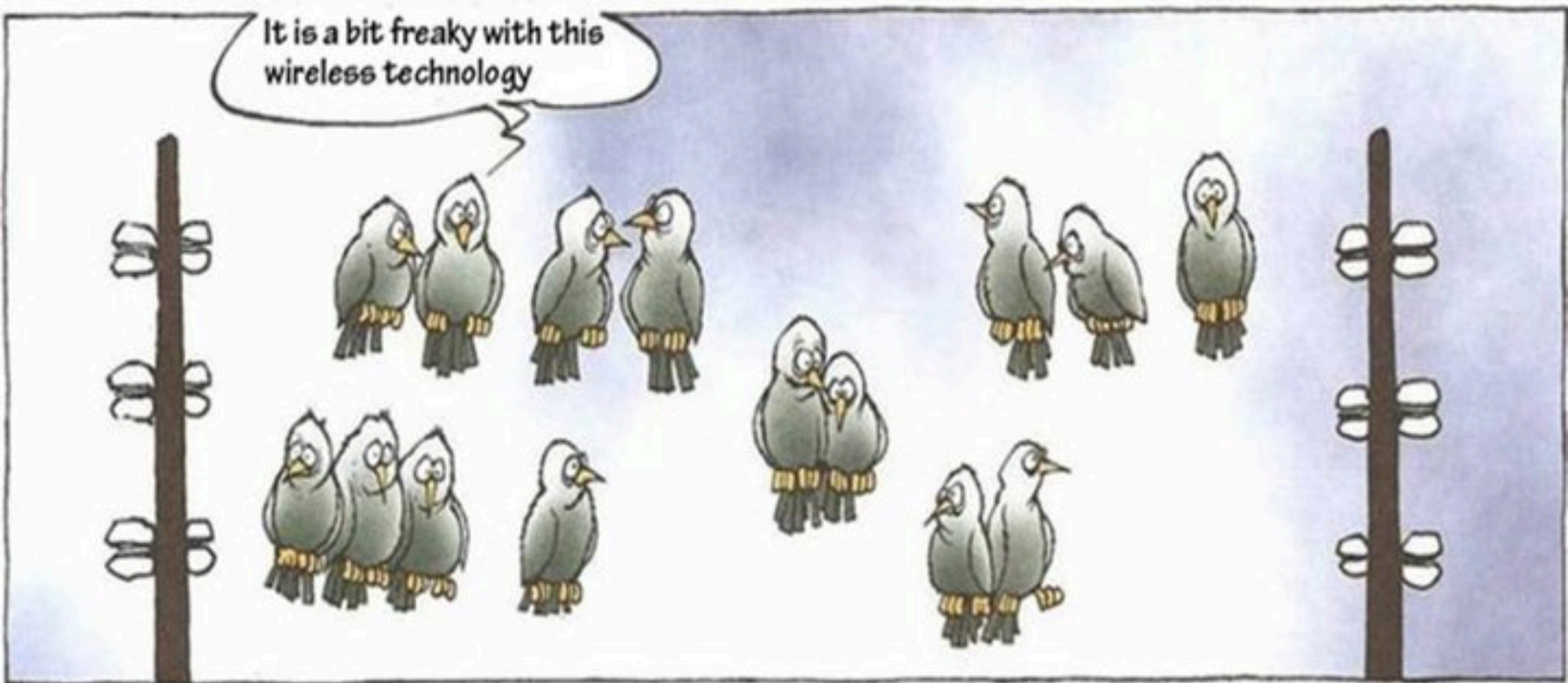

COPYRIGHT : MORTEN INGEMANN

protocol LAN due to the easy comparison and convenience in the **digital home**. While consumer PC products has just started to migrate to a much higher bandwidth of 802.11n wireless LAN now working on next-generation standard definition is already in progress.



Reliable and Safe!

This omnipresence of IT makes us not only strong but also vulnerable.

- A virus, a hacker, or a system failure can instantly send digital shockwaves around the world.

The hardware and software that allow all our systems to operate is becoming bigger and more complex all the time, and the capacity of networks and data storage is increasing by leaps and bounds.

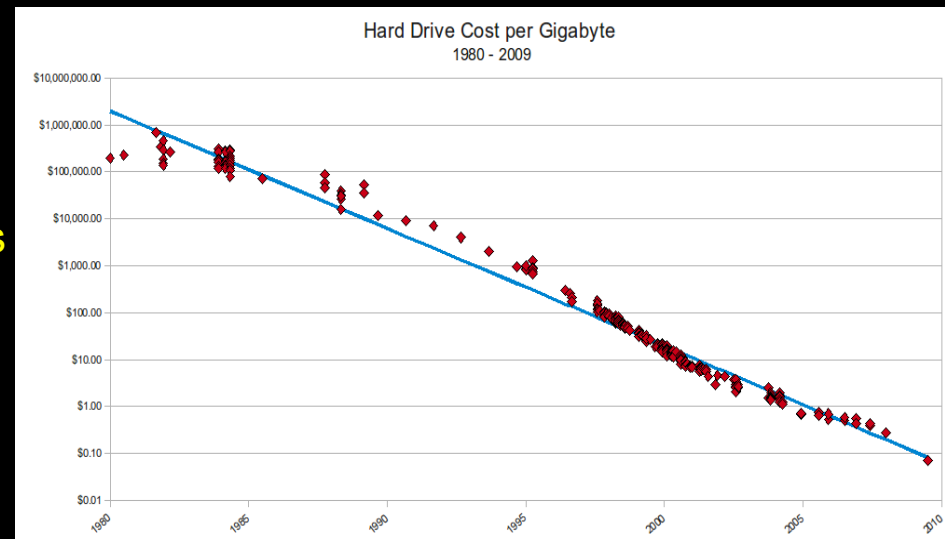

We will soon reach the limits of what is currently feasible and controllable.

Performance Development

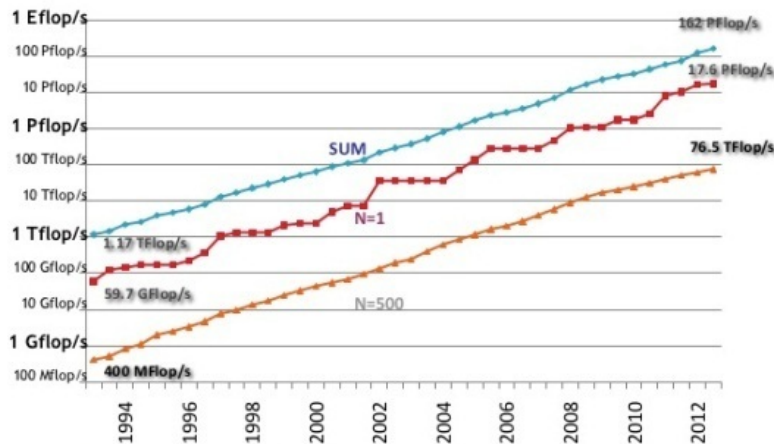

ExoGeni @ OpenLab - UvA

Installed and up June 3th 2013

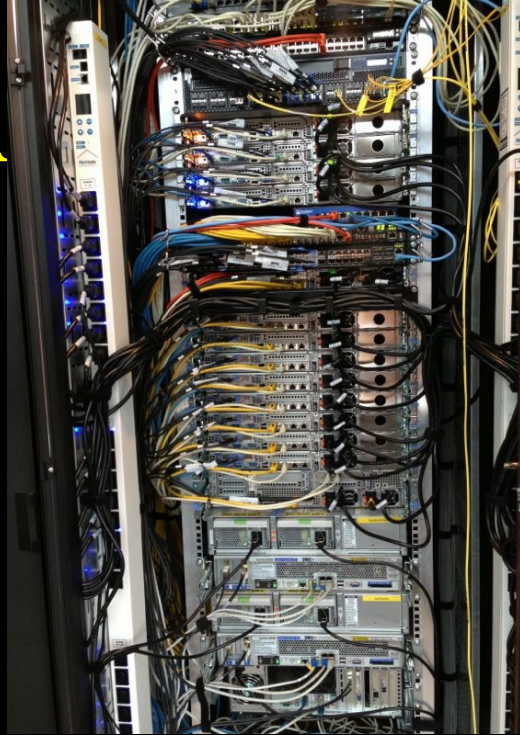

Connected via the new 100 Gb/s transatlantic To US-GENI

TNC2013 DEMOS JUNE, 2013

DEMO	TITLE	OWNER	AFFILIATION	E-MAIL	A-SIDE	Z-SIDE	PORTS(S) MAN LAN	PORTS(S) TNC2013	DETAILS
1	Big data transfers with multipathing, OpenFlow and MPTCP	Ronald van der Pol	SURFnet	ronald.vanderpol@surfnet.nl	TNC/MECC, Maastricht NL	Chicago, IL	Existing 100G link between internet2 and ESnet	2x40GE (Juniper)-2x10GE (OME6500)	In this demonstration we show how multipathing, OpenFlow and Multipath TCP (MPTCP) can help in large file transfers between data centres (Maastricht and Chicago). An OpenFlow application provisions multiple paths between the servers and MPTCP will be used on the servers to simultaneously send traffic across all these paths. This demo uses 2x40GE on the transatlantic 100G link. ESnet provides 2x40G between MAN LAN and StarLight, ACE and USLHCnet provide additional 10GEs.
2	Visualize 100G traffic	Inder Monga	ESnet	imonga@es.net					Using an SNMP feed from the Juniper switch at TNC2013 and/or Brocade AL25 node in MANLAN, this demo would visualize the total traffic on the link, of all demos aggregated. The network diagram will show the transatlantic topology and some of the demo topologies.
3	How many modern servers can fill a 100Gbps Transatlantic Circuit?	Inder Monga	ESnet	imonga@es.net	Chicago, Ill	TNC showfloor	1x 100GE	8x 10GE	In this demonstration, we show that with the proper tuning and test, only 2 hosts on each continent can generate almost 80Gbps of traffic. Each server has 4 10G NICs connected to a 40G virtual circuit, and has iperf3 running to generate traffic. ESnet's new 'iperf3' throughput measurement tool, still in beta, combines the best features from other tools such as iperf, netperf, and netcat. See: https://my.safelink.com/tnc2013/
4	First European ExoGeni at Work	Jeroen van der Ham	UvA	vdham@uva.nl	RENCI, NC	UvA, Amsterdam, NL	1x 10GE	1x 10GE	The ExoGENI racks at RENC1 and UvA will be interconnected over a 10G pipe and be on continuously, showing GENI connectivity between Amsterdam and the rest of the GENI nodes in the USA.
5	Up and down North Atlantic @ 100G	Michael Enrico	DANTE	michael.enrico@dante.net	TNC showfloor	TNC showfloor	1x 100GE	1x 100GE	The DANTE 100GE test set will be placed at the TNC2013 showfloor and connected to the Juniper at 100G. When this demo is running a loop @ MAN LAN's Brocade switch will ensure that the traffic sent to MAN LAN returns to the showfloor. On display is the throughput and RTT (to show the traffic travelled the Atlantic twice)



Amsterdam is a major hub in The GLIF

F Dijkstra, J van der Ham, P Grosso, C de Laat, "A path finding implementation for multi-layer networks", Future Generation Computer Systems 25 (2), 142-146.

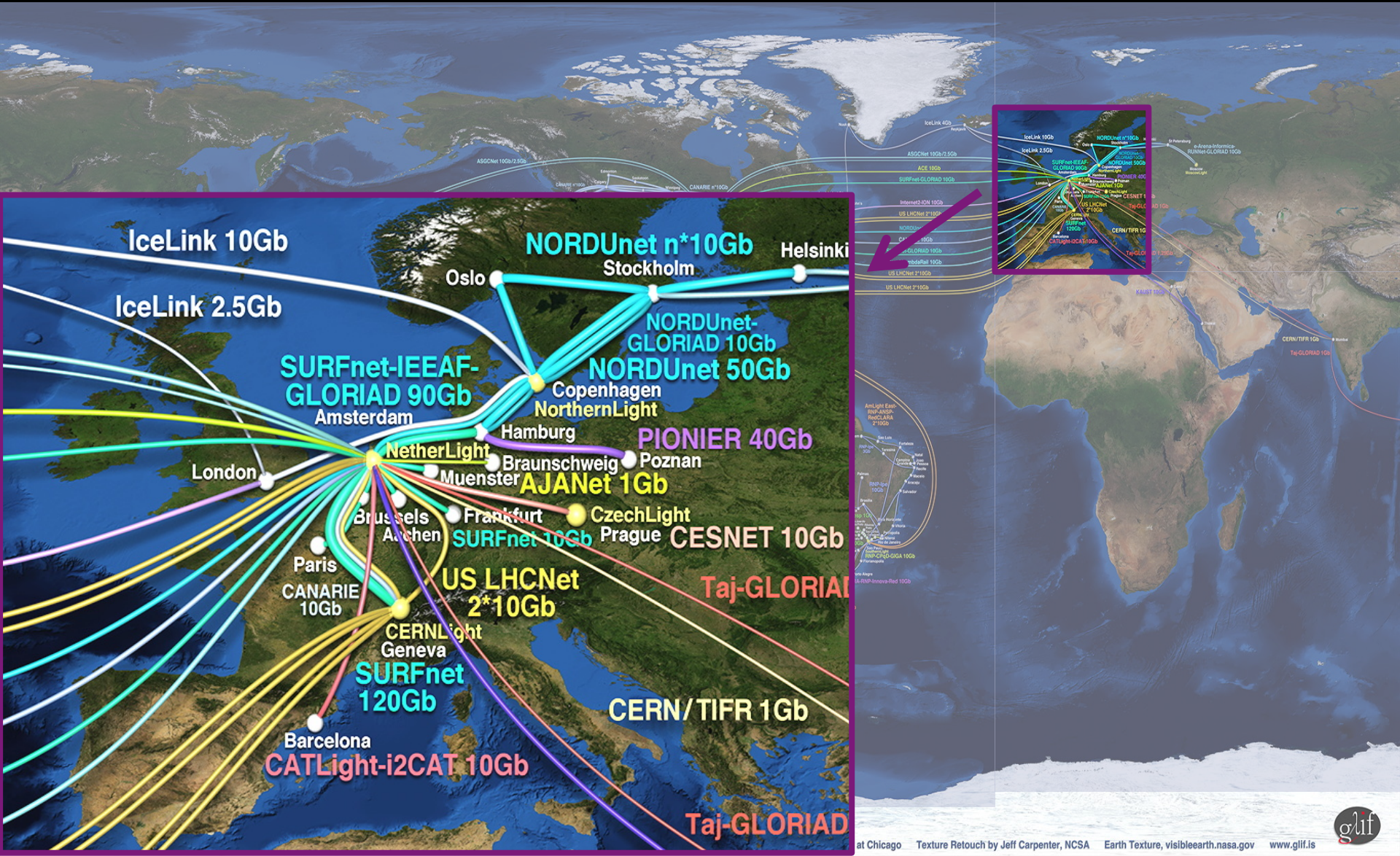

Alien light From idea to realisation!

40Gb/s alien wavelength transmission via a multi-vendor 10Gb/s DWDM infrastructure



Alien wavelength advantages

- Direct connection of customer equipment^[1] → cost savings
- Avoid OEO regeneration → power savings
- Faster time to service^[2] → time savings
- Support of different modulation formats^[3] → extend network lifetime

Alien wavelength challenges

- Complex end-to-end optical path engineering in terms of linear (i.e. OSNR, dispersion) and non-linear (FWM, SPM, XPM, Raman) transmission effects for different modulation formats.
- Complex interoperability testing.
- End-to-end monitoring, fault isolation and resolution.
- End-to-end service activation.

In this demonstration we will investigate the performance of a 40Gb/s PM-QPSK alien wavelength installed on a 10Gb/s DWDM infrastructure.

New method to present fiber link quality, FoM (Figure of Merit)

In order to quantify optical link grade, we propose a new method of representing system quality: the FOM (Figure of Merit) for concatenated fiber spans.

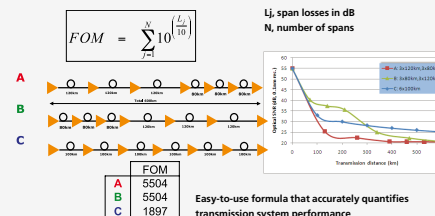

Transmission system setup

JOINT SURFnet/NORDUnet 40Gb/s PM-QPSK alien wavelength DEMONSTRATION.

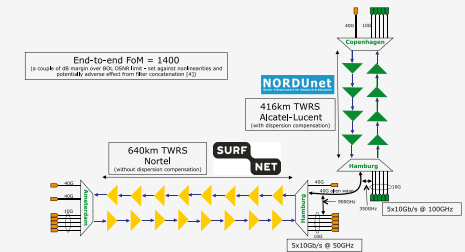

Test results

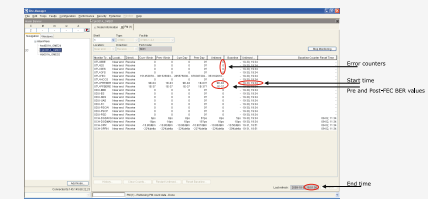

Error-free transmission for 23 hours, 17 minutes → BER < 3,0 10⁻¹⁶

Conclusions

- We have investigated experimentally the all-optical transmission of a 40Gb/s PM-QPSK alien wavelength via a concatenated native and third party DWDM system that both were carrying live 10Gb/s wavelengths.
- The end-to-end transmission system consisted of 1056 km of TWRS (TrueWave Reduced Slope) transmission fiber.
- We demonstrated error-free transmission (i.e. BER below 10⁻¹⁵) during a 23 hour period.
- More detailed system performance analysis will be presented in an upcoming paper.



REFERENCES
ACKNOWLEDGEMENTS

[1] "OPERATIONAL SOLUTIONS FOR AN OPEN DWDM LAYER", O. GERSTEL ET AL. OFC2009 | [2] "AT&T OPTICAL TRANSPORT SERVICES", BARBARA E. SMITH, OFC'09
[3] "OPEX SAVINGS OF ALL-OPTICAL CORE NETWORKS", ANDREW LORD AND CARL ENGINEER, ECCO2009 | [4] NORTEL/SURFNET INTERNAL COMMUNICATION
WE ARE GRATEFUL TO NORDUNET FOR PROVIDING US WITH BANDWIDTH ON THEIR DWDM LINK FOR THIS EXPERIMENT AND ALSO FOR THEIR SUPPORT AND ASSISTANCE DURING THE EXPERIMENTS. WE ALSO ACKNOWLEDGE TELINDUS AND NORTEL FOR THEIR INTEGRATION WORK AND SIMULATION SUPPORT

Alien light From idea to realisation!

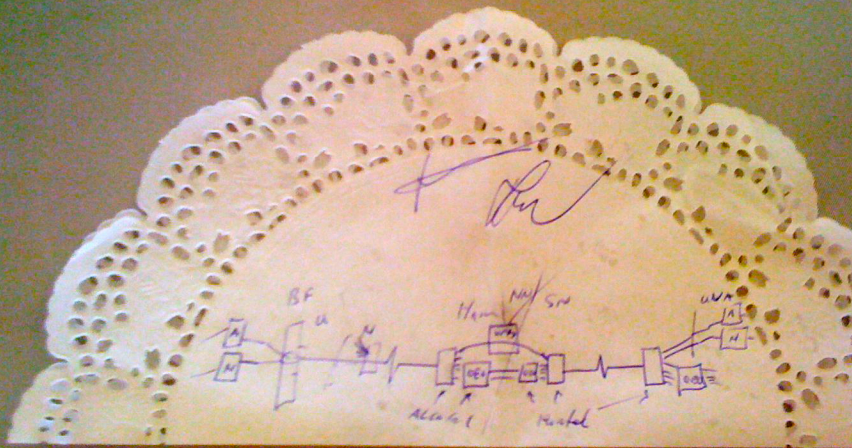

40Gb/s alien wavelength transmission via a multi-vendor 10Gb/s DWDM infrastructure



Alien wavelength advantages

- Direct connection of customer equipment^[1] → cost savings
- Avoid OEO regeneration → power savings
- Faster time to service^[2] → time savings
- Support of different modulation formats^[3] → extend network lifetime

Alien wavelength challenges

- Complex end-to-end optical path engineering in terms of linear (i.e. OSNR, dispersion) and non-linear (FWM, SPM, XPM, Raman) transmission effects for different modulation formats.
- Complex interoperability testing.
- End-to-end monitoring, fault isolation and resolution.
- End-to-end service activation.

In this demonstration we will investigate the performance of a 40Gb/s PM-QPSK alien wavelength installed on a 10Gb/s DWDM infrastructure.

New method to present fiber link quality, FoM (Figure of Merit)

In order to quantify optical link grade, we propose a new method of representing system quality: the FOM (Figure of Merit) for concatenated fiber spans.

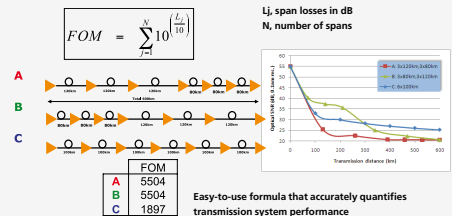

Transmission system setup

JOINT SURFnet/NORDUnet 40Gb/s PM-QPSK alien wavelength DEMONSTRATION.

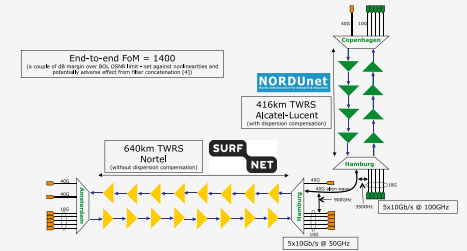

Test results

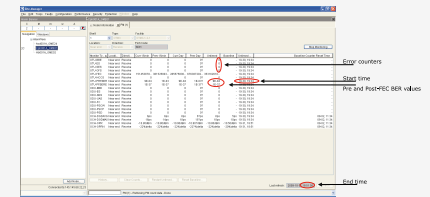

Error-free transmission for 23 hours, 17 minutes → BER < 3,0 · 10⁻¹⁶

Conclusions

- We have investigated experimentally the all-optical transmission of a 40Gb/s PM-QPSK alien wavelength via a concatenated native and third party DWDM system that both were carrying live 10Gb/s wavelengths.
- The end-to-end transmission system consisted of 1056 km of TWRS (TrueWave Reduced Slope) transmission fiber.
- We demonstrated error-free transmission (i.e. BER below 10⁻¹⁵) during a 23 hour period.
- More detailed system performance analysis will be presented in an upcoming paper.



REFERENCES
ACKNOWLEDGEMENTS

[1] "OPERATIONAL SOLUTIONS FOR AN OPEN DWDM LAYER", O. GERSTEL ET AL. OFC2009 | [2] "AT&T OPTICAL TRANSPORT SERVICES", BARBARA E. SMITH, OFC'09
[3] "OPEX SAVINGS OF ALL-OPTICAL CORE NETWORKS", ANDREW LORD AND CARL ENGINEER, ECCO2009 | [4] NORTEL/SURFNET INTERNAL COMMUNICATION
WE ARE GRATEFUL TO NORDUNET FOR PROVIDING US WITH BANDWIDTH ON THEIR DWDM LINK FOR THIS EXPERIMENT AND ALSO FOR THEIR SUPPORT AND ASSISTANCE DURING THE EXPERIMENTS. WE ALSO ACKNOWLEDGE TELINDUS AND NORTEL FOR THEIR INTEGRATION WORK AND SIMULATION SUPPORT

ClearStream @ TNC2011

Setup
codename:
FlightCees



UvA

iPerf
17 3.2 GHz Q-core

iPerf
Amd Ph II 3.6 GHz HexC

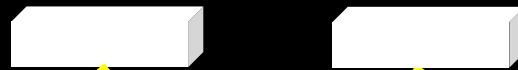

Mellanox
40G E



Copenhagen

iPerf
2* dual 2.8 GHz Q-core

iPerf
2* dual 2.8 GHz Q-core

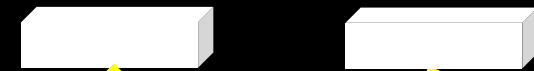

Mellanox



CERN

CIENA DWDM

17 ms RTT

Hamburg

Alcatel DWDM

27 ms RTT

Amsterdam – Geneva (CERN) – Copenhagen – 4400 km (2700 km alien light)

Visit CIENA Booth

surf to <http://tnc.delaat.net/tnc11>

ClearStream

End-to-End Ultra Fast Transmission Over a Wide Area 40 Gbit/s Lambda

Amsterdam (Uva) Live RX Traffic

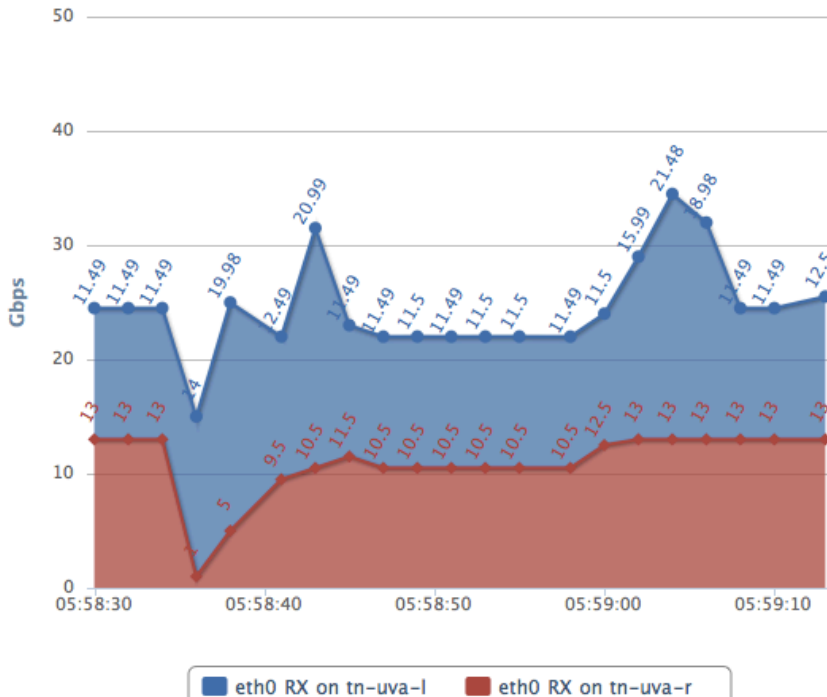

Highcharts.com

Incoming Amsterdam 25.5 Gbps

Incoming Copenhagen 20.97 Gbps

Total Throughput **46.47 Gbps** RTT **44.032 ms**

Copenhagen POP RX Traffic

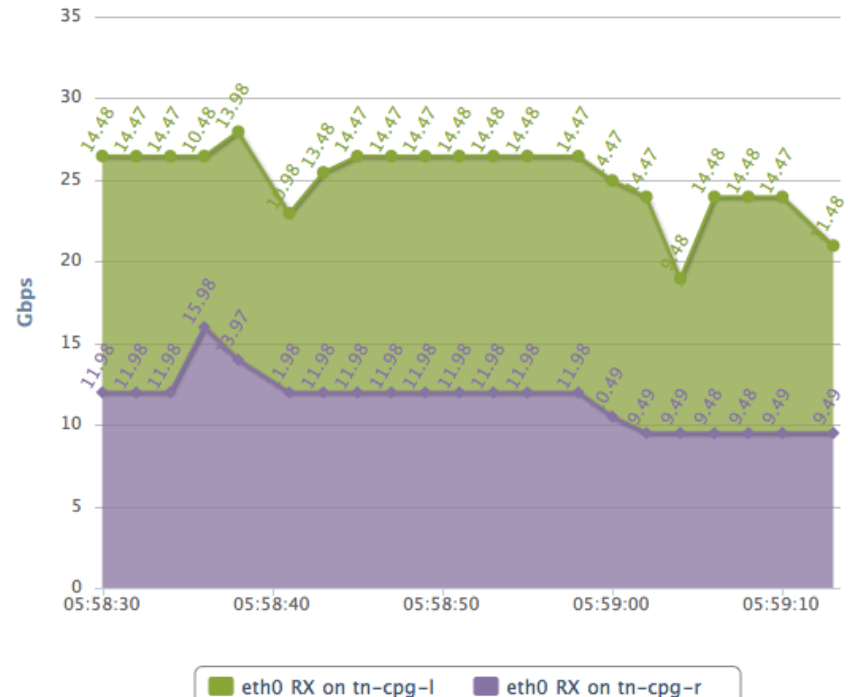

Highcharts.com

Results (rtt = 17 ms)

- ❑ Single flow iPerf 1 core -> 21 Gbps
- ❑ Single flow iPerf 1 core <> -> 15+15 Gbps
- ❑ Multi flow iPerf 2 cores -> 25 Gbps
- ❑ Multi flow iPerf 2 cores <> -> 23+23 Gbps
- ❑ DiViNe <> -> 11 Gbps
- ❑ Multi flow iPerf + DiVine -> 35 Gbps
- ❑ Multi flow iPerf + DiVine <> -> 35 + 35 Gbps

Server Architecture

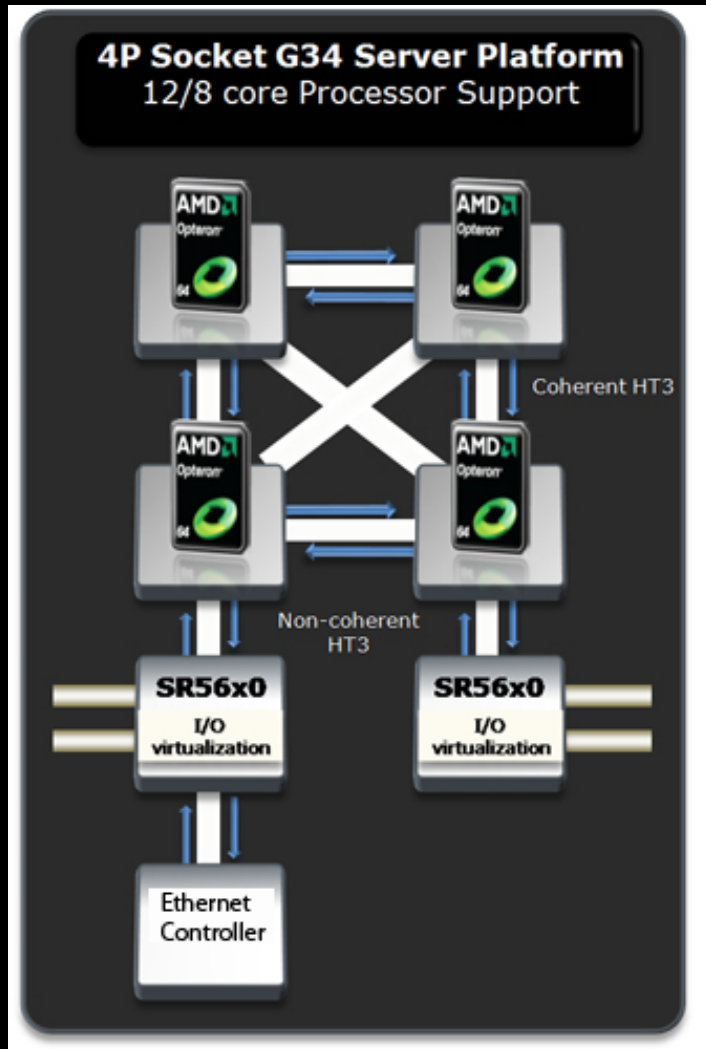

DELL R815

4 x AMD Opteron 6100

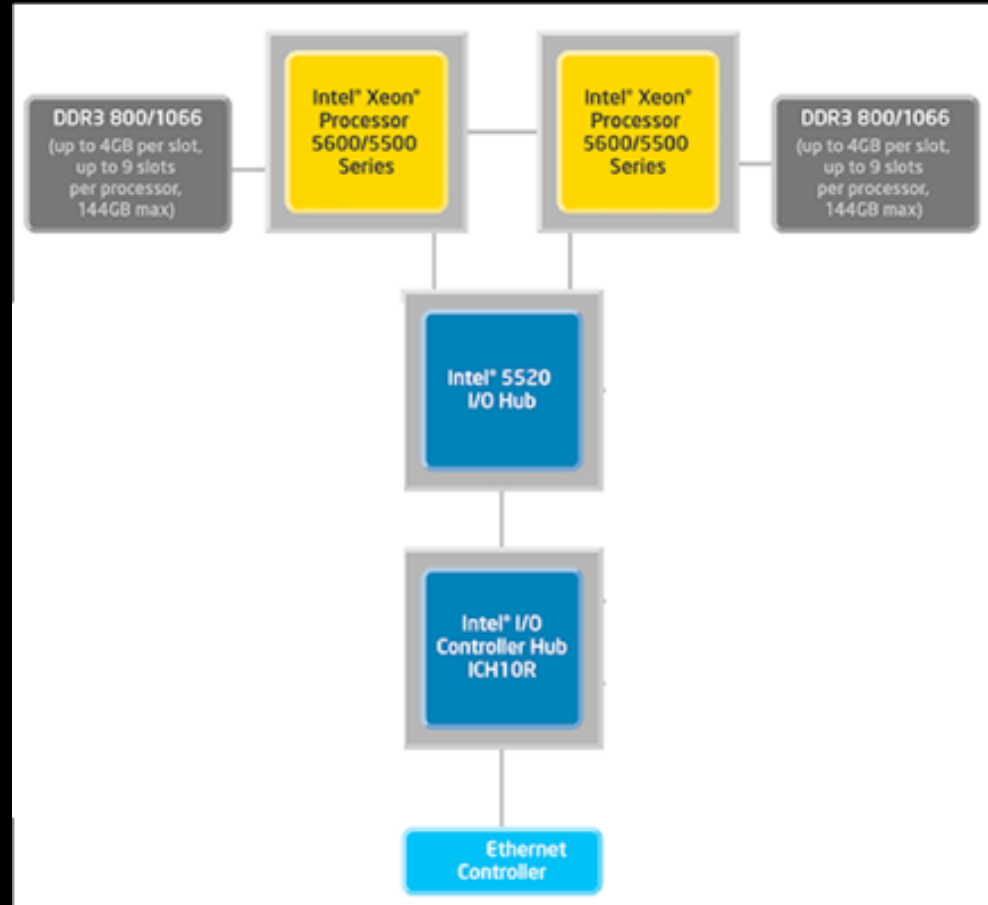

Supermicro X8DTT-HIBQF

2 x Intel Xeon

CPU Topology benchmark

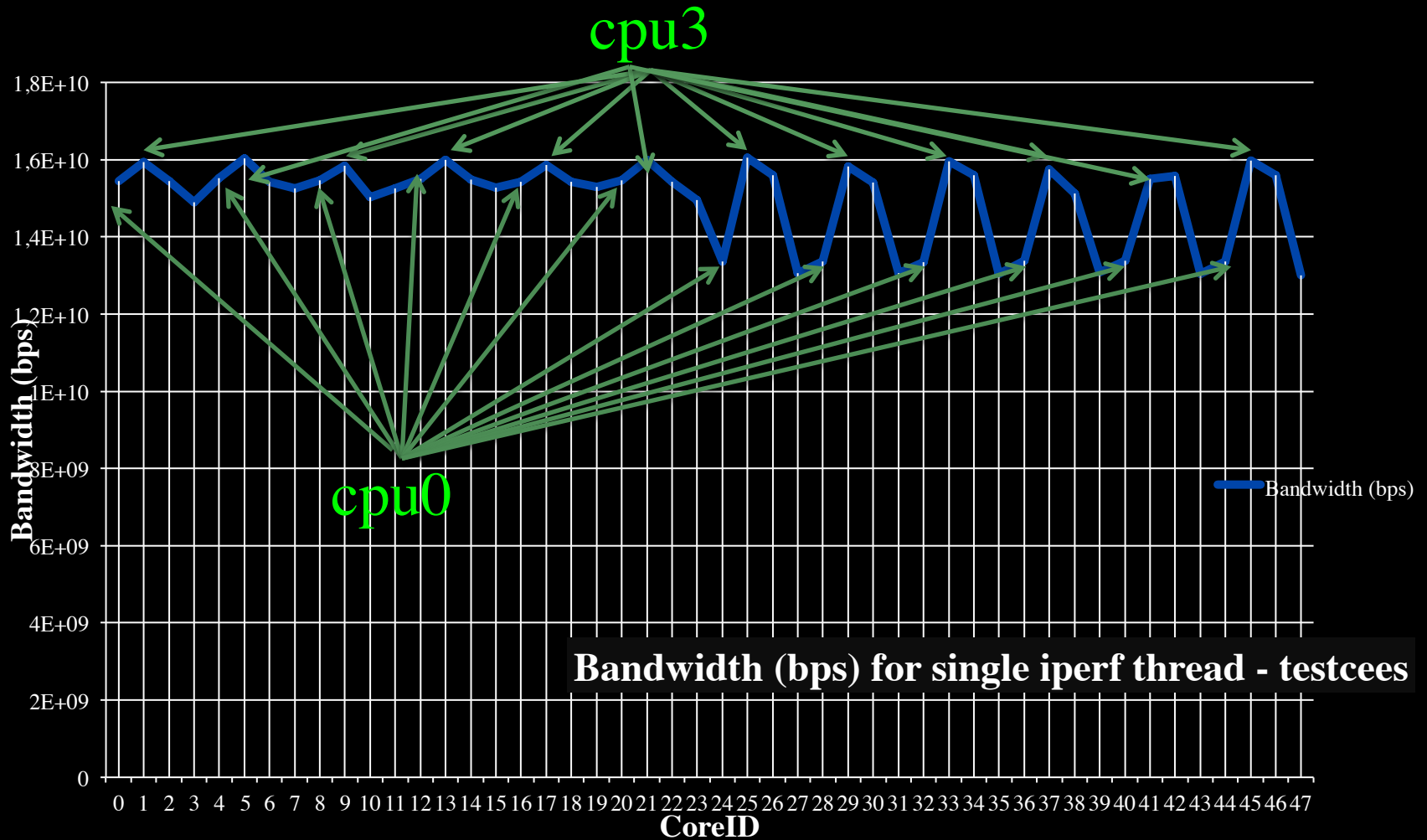

We used numactl to bind iperf to cores

Mission

Can we create smart and safe data processing infrastructures that can be tailored to diverse application needs?

- *Capacity*
 - *Bandwidth on demand, QoS, architectures, photonics, performance*
- ***Capability***
 - ***Programmability, virtualization, complexity, semantics, workflows***
- *Security*
 - *Anonymity, integrity of data in distributed data processing*
- *Sustainability*
 - *Greening infrastructure, awareness*
- *Resilience*
 - *Systems under attack, failures, disasters*



LinkedIn for Infrastructure



- From semantic Web / Resource Description Framework.
- The RDF uses XML as an interchange syntax.
- Data is described by triplets (Friend of a Friend):

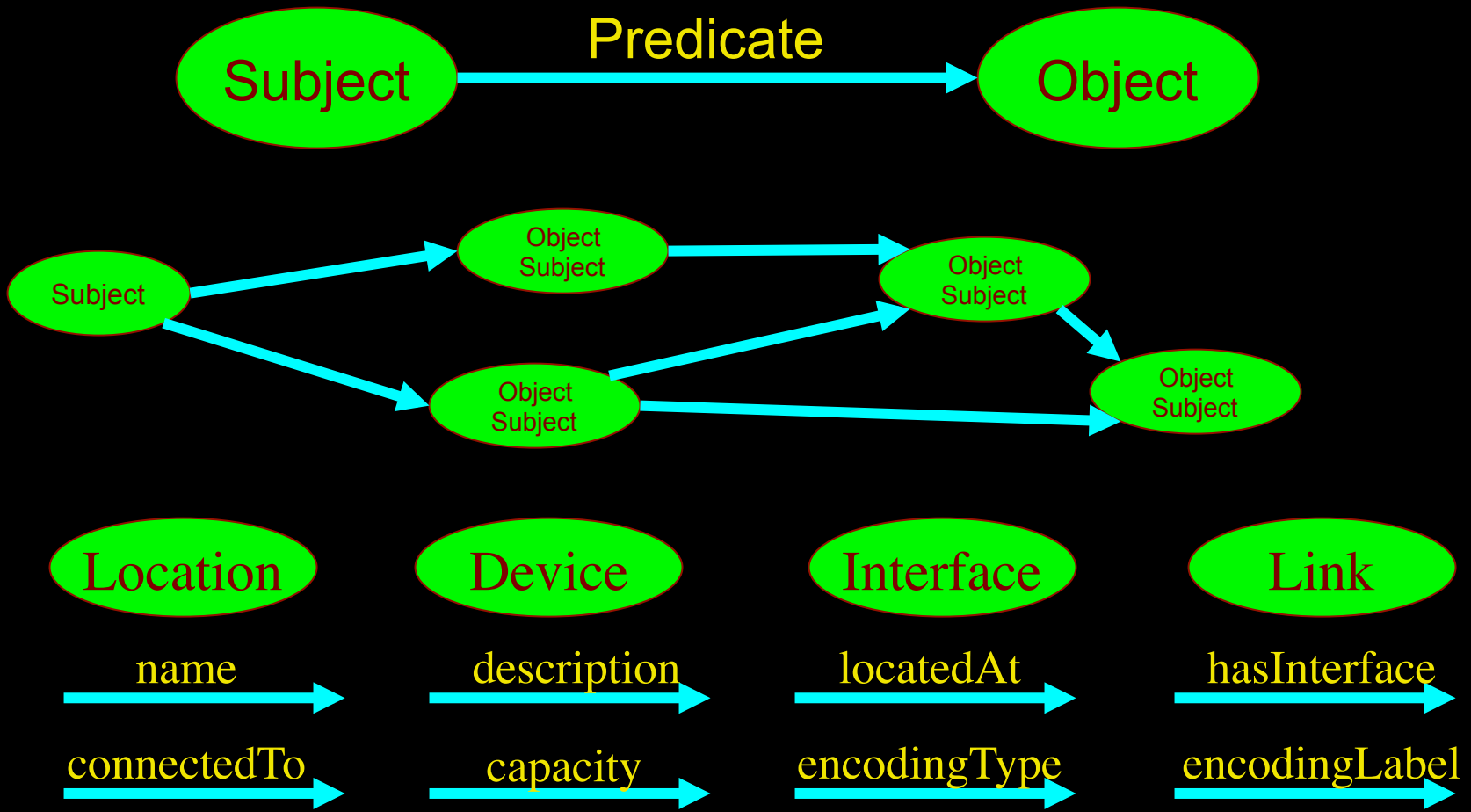

Network Description Language

Article: F. Dijkstra, B. Andree, K. Koymans, J. van der Ham, P. Grosso, C. de Laat, "A Multi-Layer Network Model Based on ITU-T G.805"

Choice of RDF instead of XML syntax

Grounded modeling based on G805 description:

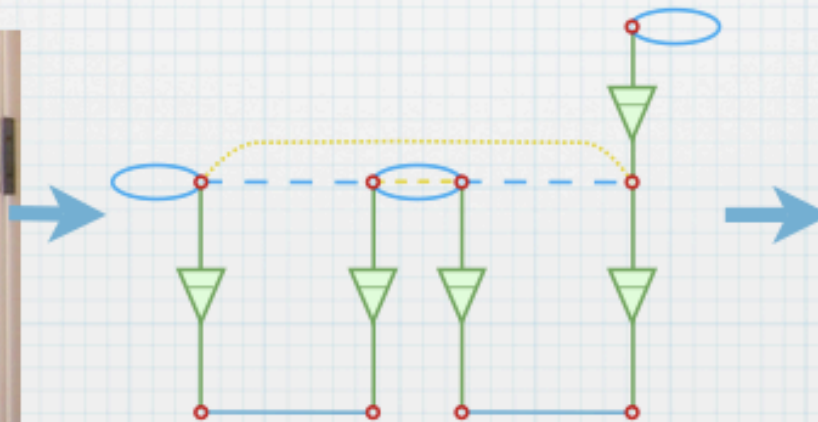
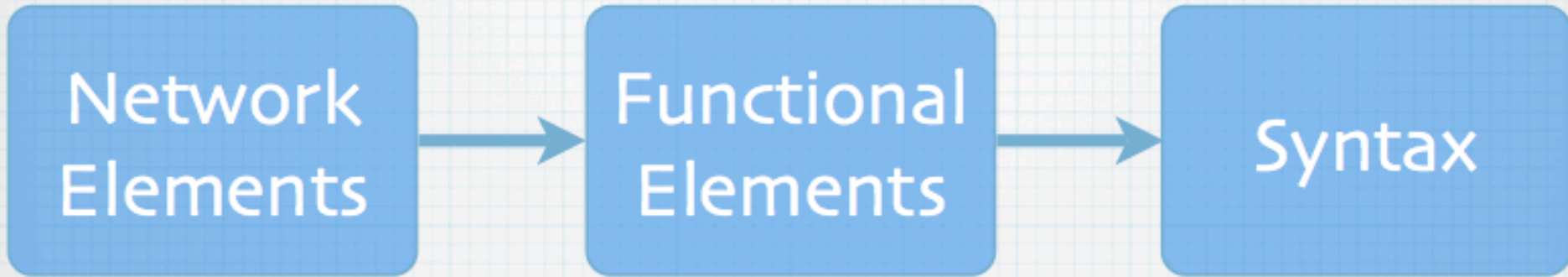

```
<ndl:Device rdf:about="#Force10">
  <ndl:hasInterface rdf:resource=
    "#Force10:te6/0"/>
</ndl:Device>
<ndl:Interface rdf:about="#Force10:te6/0">
  <rdfs:label>te6/0</rdfs:label>
  <ndl:capacity>1.25E6</ndl:capacity>
  <ndlconf:multiplex>
    <ndicap:adaptation rdf:resource=
      "#Tagged-Ethernet-In-Ethernet"/>
    <ndlconf:serverPropertyValue
      rdf:resource="#MTU-1500byte"/>
  </ndlconf:multiplex>
  <ndlconf:hasChannel>
    <ndlconf:Channel rdf:about=
      "#Force10:te6/0:vlan4">
      <ndleth:hasVlan>4</ndleth:hasVlan>
      <ndlconf:switchedTo rdf:resource=
        "#Force10:gi5/1:vlan7"/>
    </ndlconf:Channel>
  </ndlconf:hasChannel>
</ndl:Interface>
```

NML OFG spec

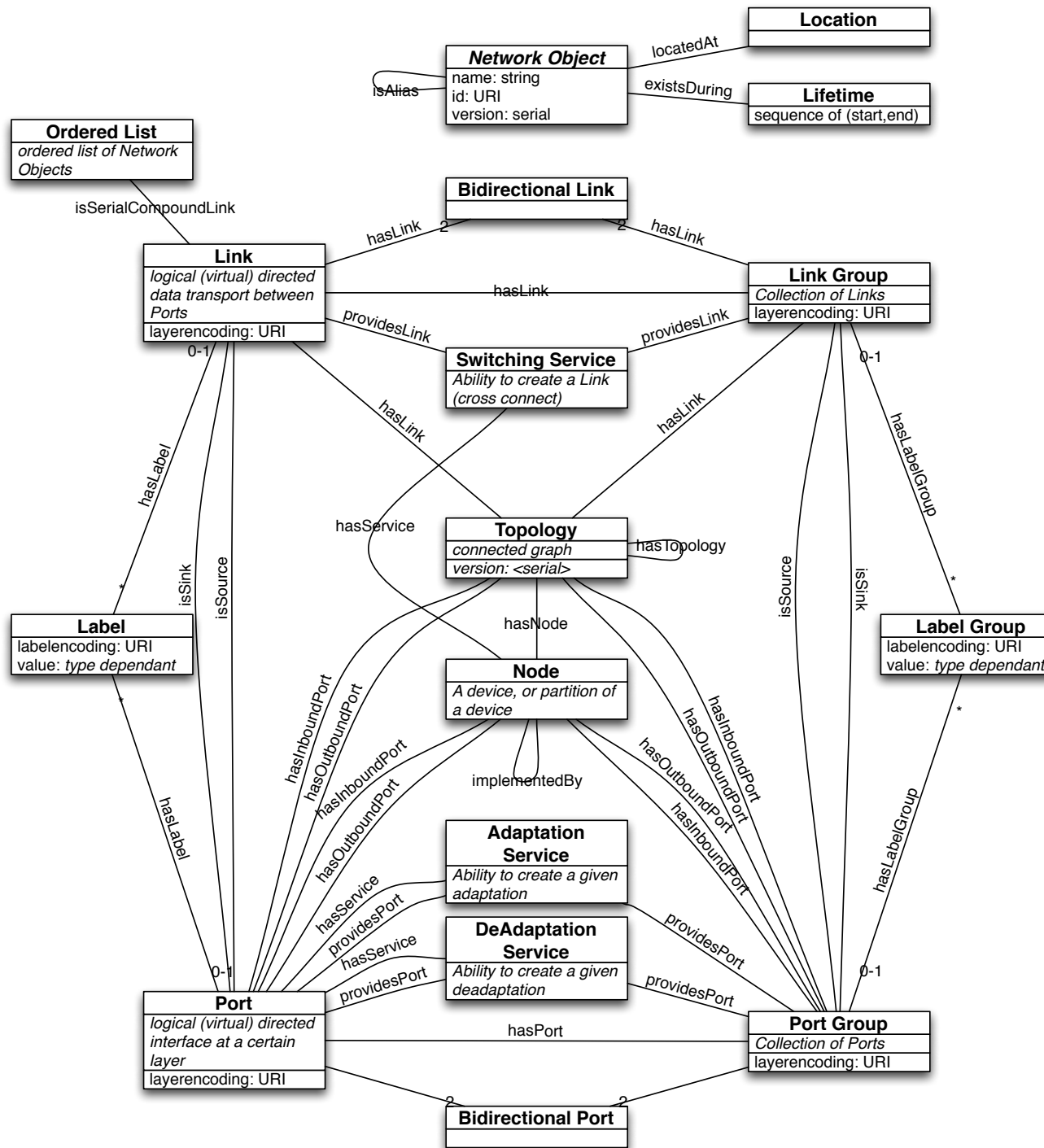

Multi-layer descriptions in NDL

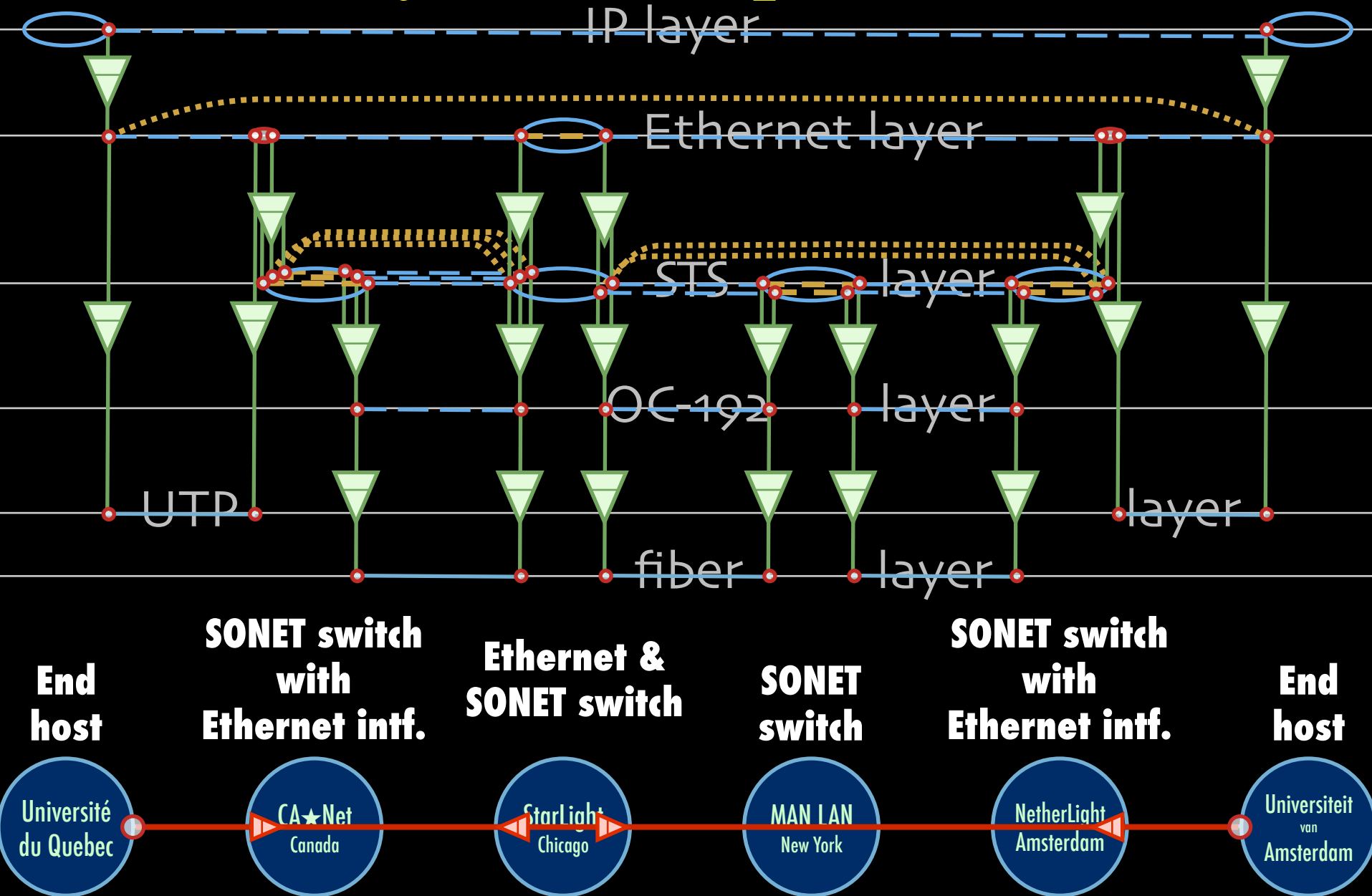

Multi-layer Network PathFinding

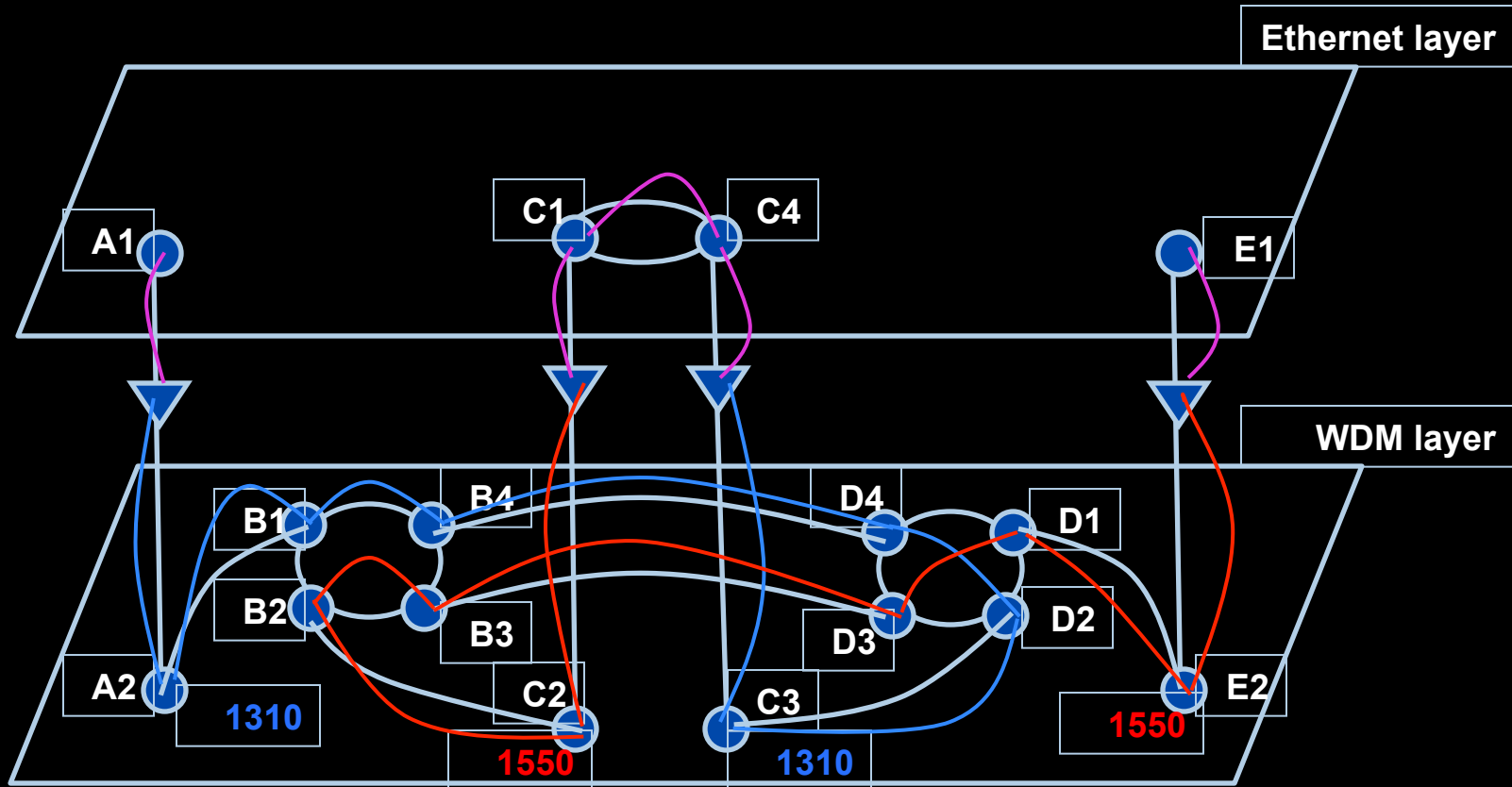

Path between interfaces A1 and E1:
A1-A2-B1-B4-D4-D2-C3-C4-C1-C2-B2-B3-D3-D1-E2-E1

Scaling: Combinatorial problem

Information Modeling

Define a common information model for *infrastructures* and *services*.
Base it on Semantic Web.

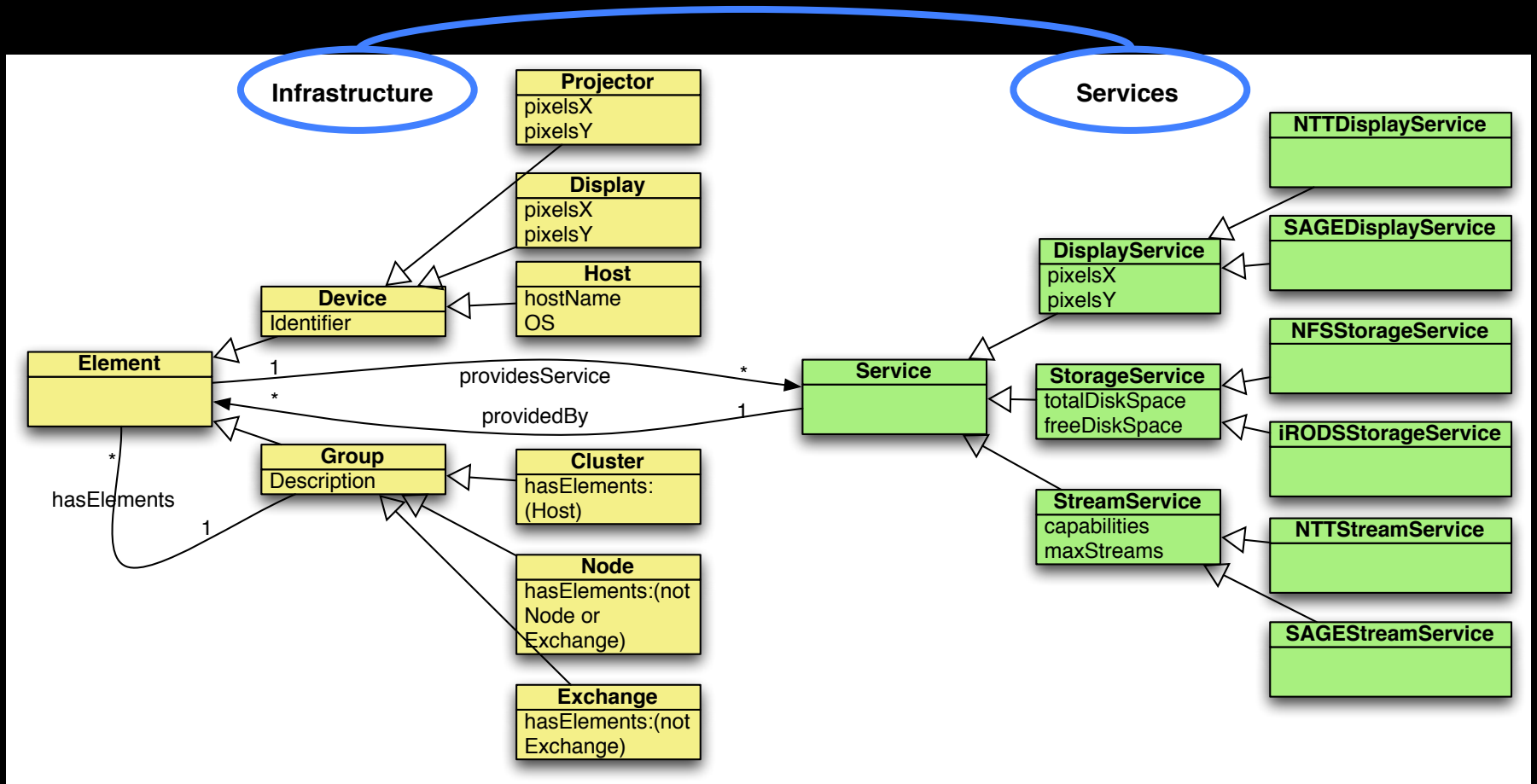

CdL

Applications and Networks become aware of each other!

CineGrid Description Language

CineGrid is an initiative to facilitate the exchange, storage and display of high-quality digital media.

The CineGrid Description Language (CDL) describes CineGrid resources. Streaming, display and storage components are organized in a hierarchical way.

CDL has bindings to the NDL ontology that enables descriptions of network components and their interconnections.

With CDL we can reason on the CineGrid infrastructure and its services.

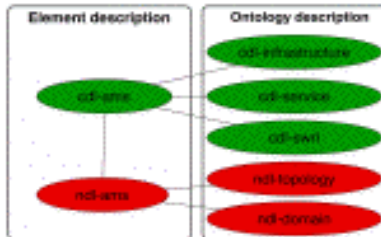

SQWRL is used to query the Ontology.

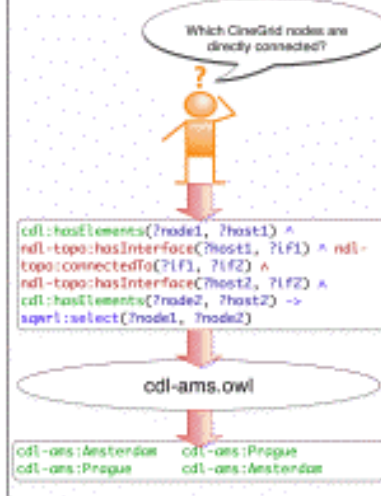

UML representation of CDL



CDL links to NDL using the *owl:SameAs* property. CDL defines the services, NDL the network interfaces and links. The combination of the two ontologies identifies the host pairs that support matching services via existing network connections.



Layers

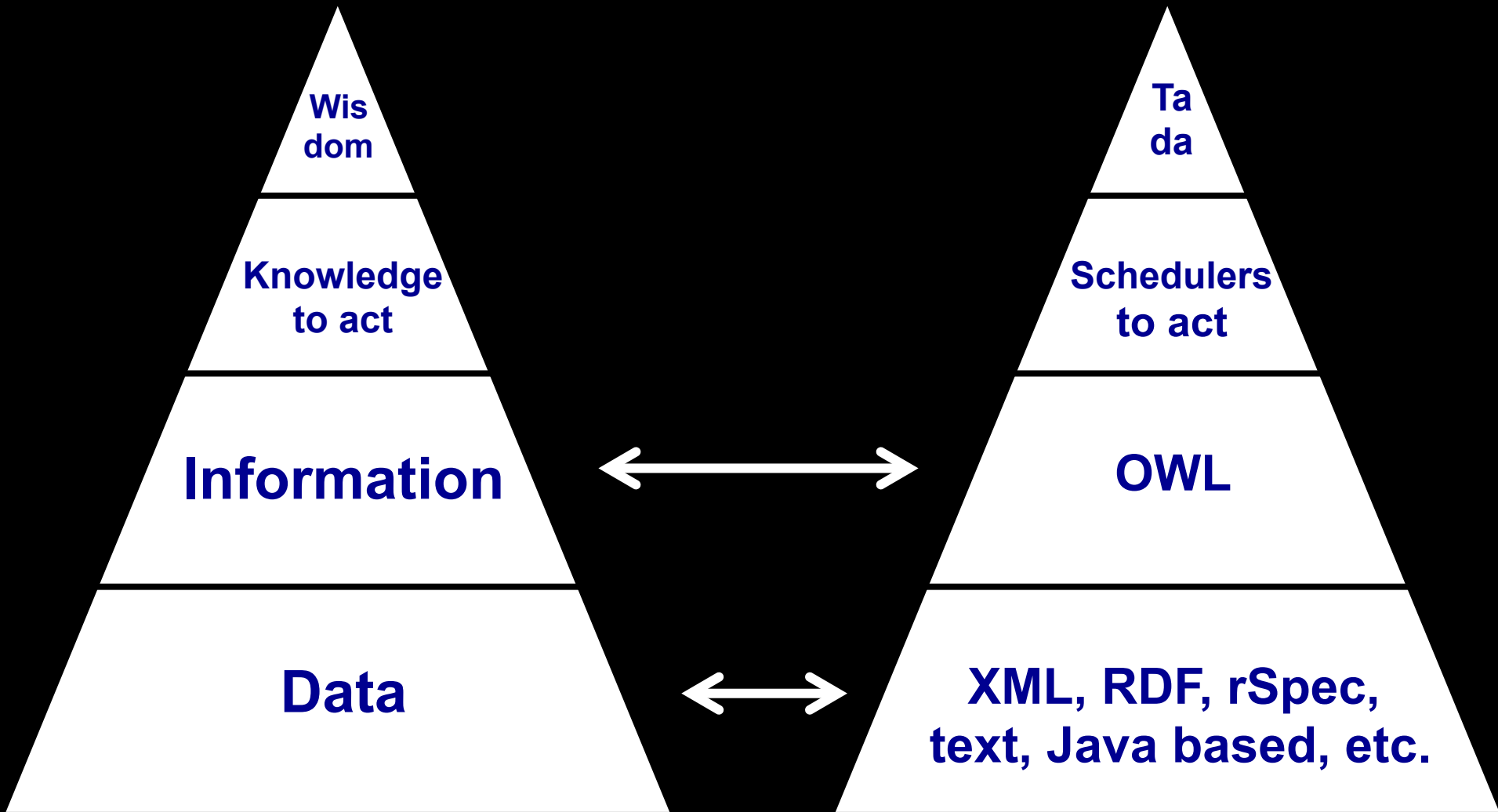

Automated GOLE + NSI

NSI v2 Beta Test Fabric Oct 2013

Ethernet Transport Service

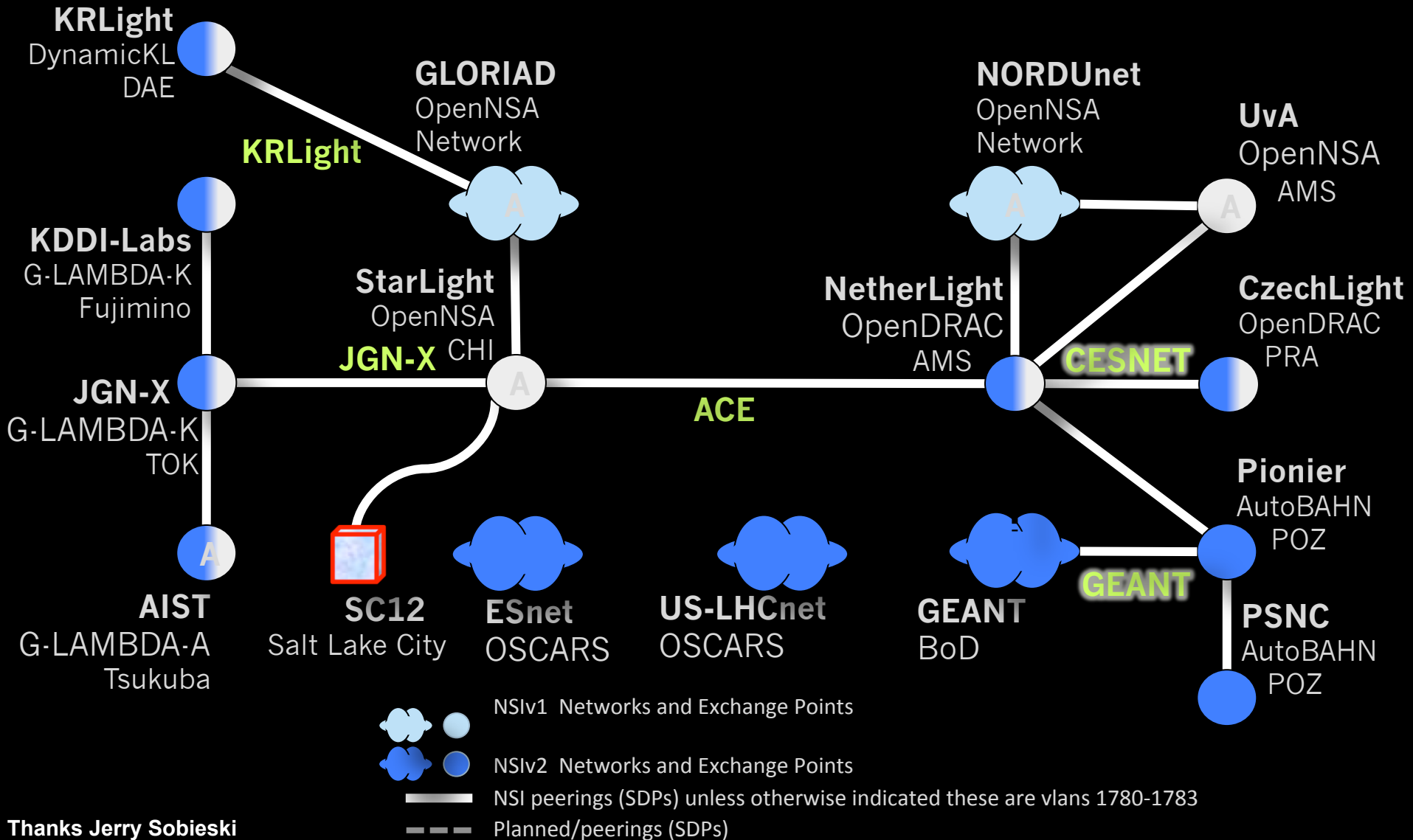

GLIF 2013 in NML

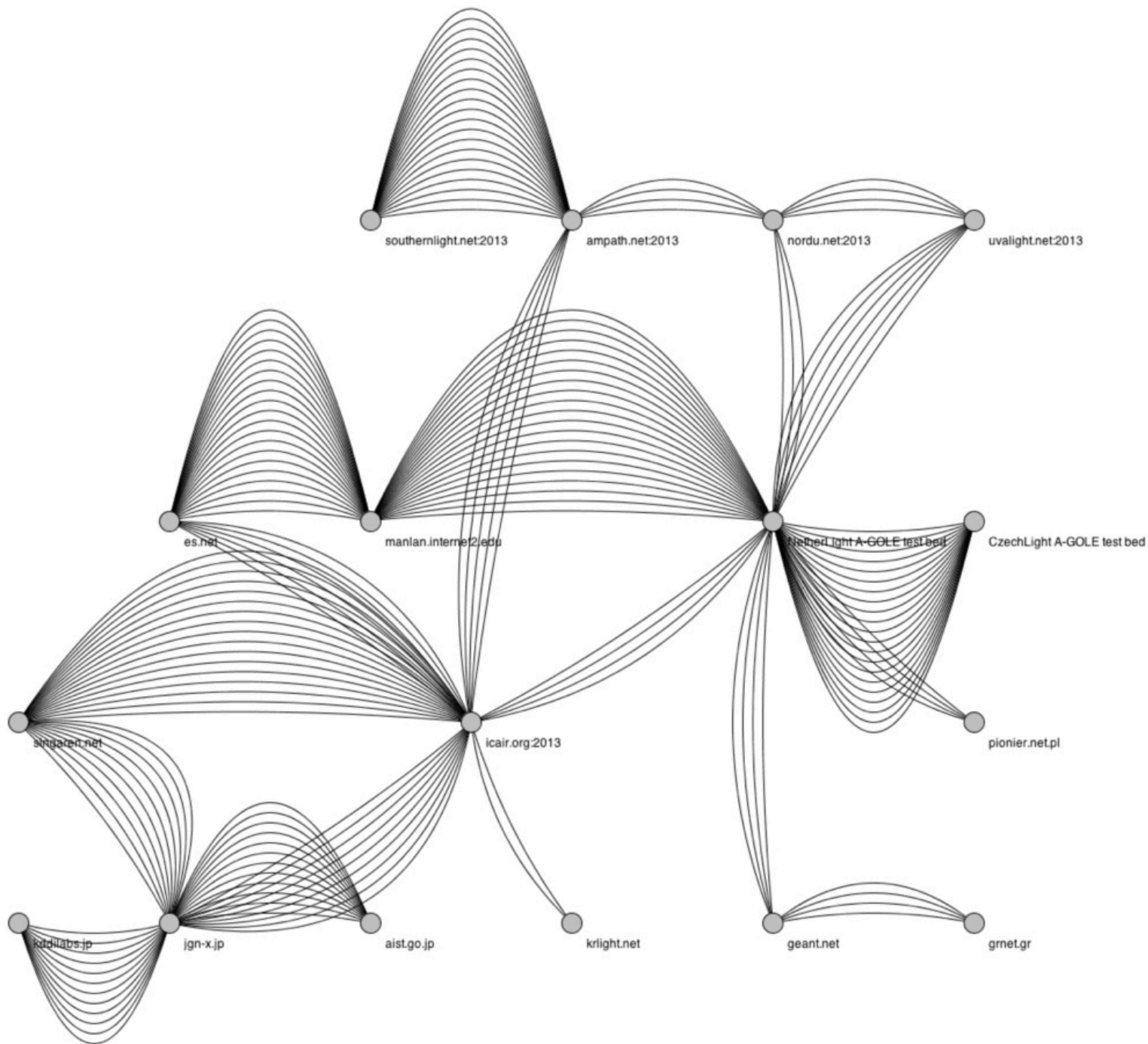

Network Topology Description

Network topology research supporting automatic network provisioning

- Inter-domain networks
- Multiple technologies
- Based on incomplete information
- Possibly linked to other resources

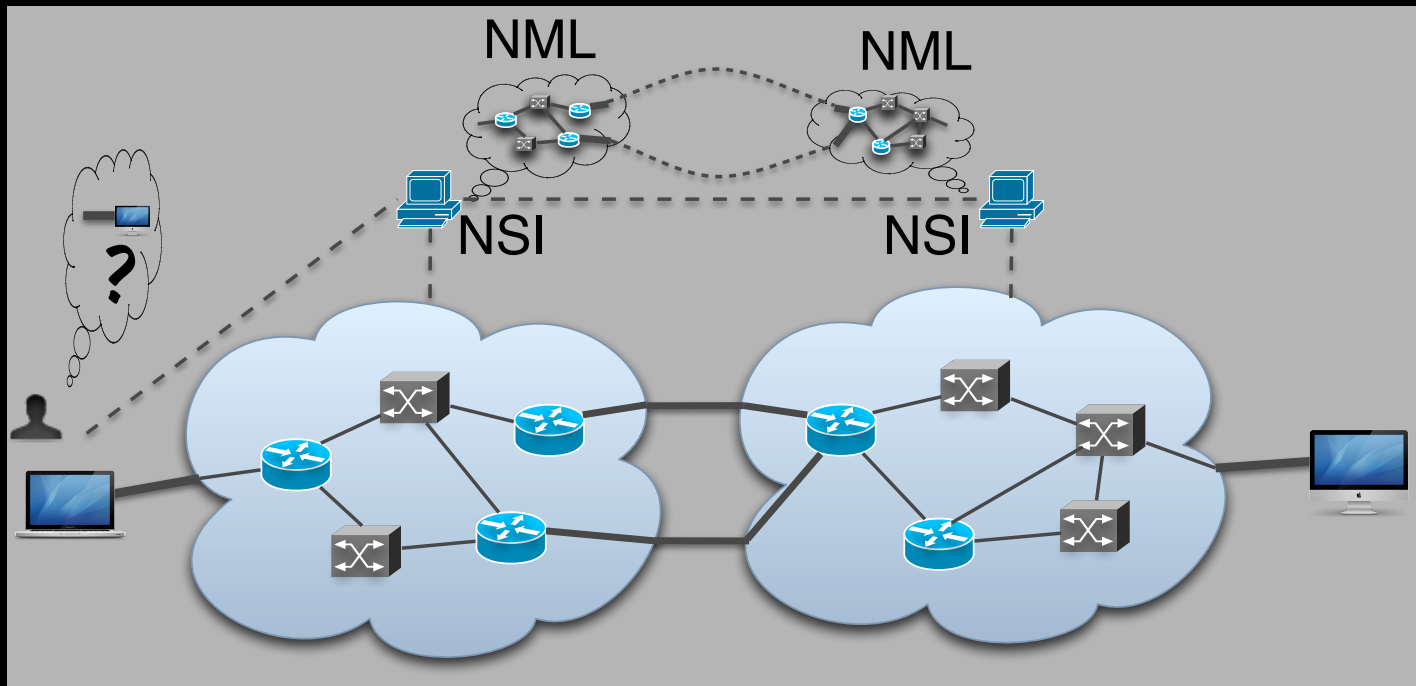

Mission

Can we create smart and safe data processing infrastructures that can be tailored to diverse application needs?

- *Capacity*
 - *Bandwidth on demand, QoS, architectures, photonics, performance*
- *Capability*
 - *Programmability, virtualization, complexity, semantics, workflows*
- ***Security***
 - ***Anonymity, integrity of data in distributed data processing***
- *Sustainability*
 - *Greening infrastructure, awareness*
- *Resilience*
 - *Systems under attack, failures, disasters*



Towards Purpose-Driven Virtual Machines

Physical Machines



N.D. Jebessa

And after a while...

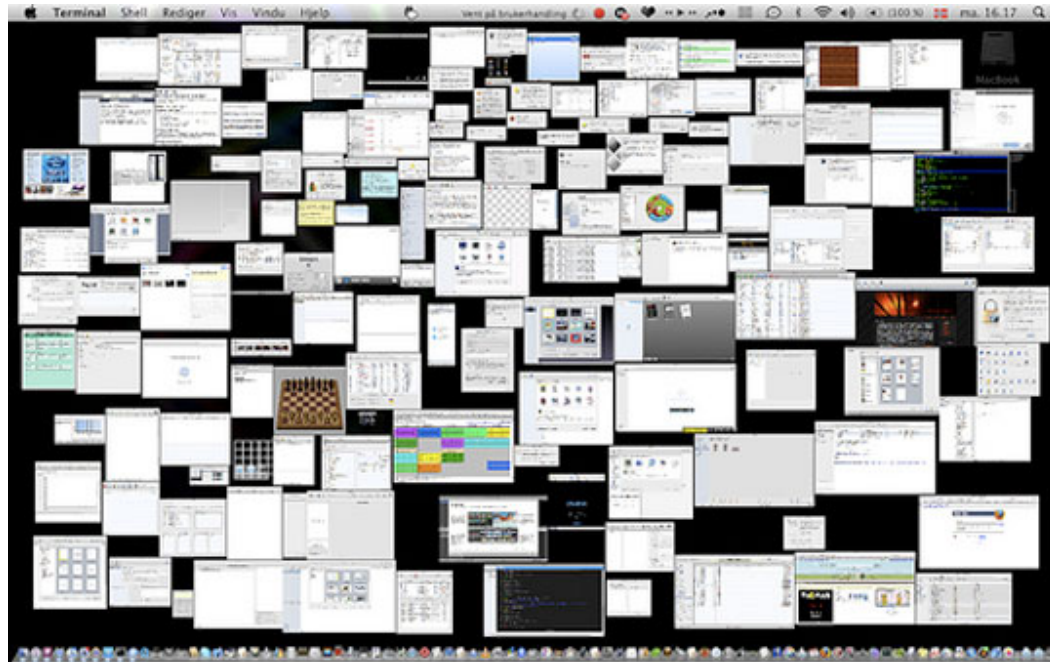

Security

Performance

Management

Purpose-Driven Virtual Machines

- ⇒ Virtual machine (**VM**) technology is a key enabler (e.g. clouds, mobility, green IT, ...)
- ⇒ Often, a VM serves a **specific purpose** (e.g. host a bioinformatics application)
- ⇒ VM **security** & data **privacy** are very important (e.g. DNA processing in clouds)
- ⇒ VMs with a general-purpose OS meant for physical machines exhibit **redundancy**
- ⇒ Generic VMs exhibit **opacity** (e.g. kernel, packages, configurations, ...)
- ⇒ A specific-purpose VM could be optimized for a **minimal TCB** (trusted computing base)
- ⇒ The VM ought to be **transparent** so as to reason about its security and **trustworthiness**

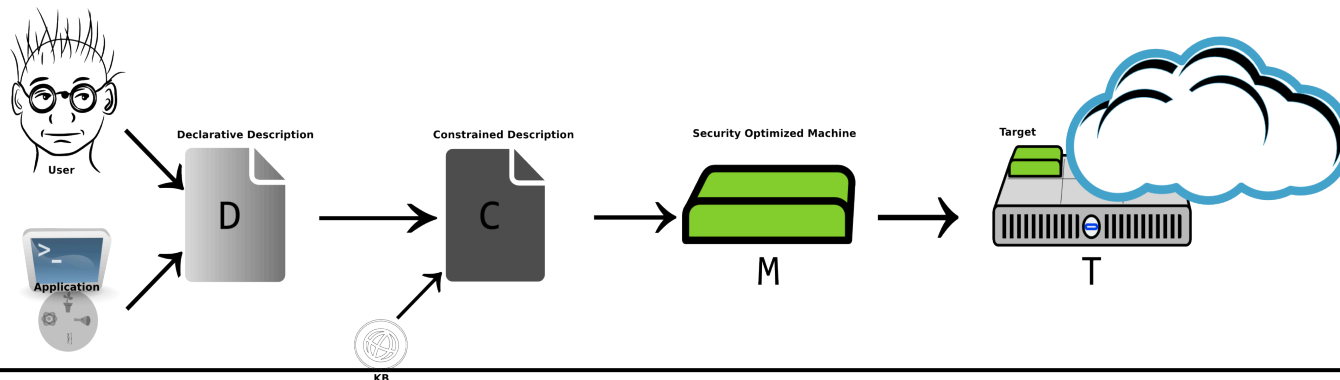

Minimal, transparent and secure VMs optimized for a specific purpose – built automatically from declarative descriptions.

Feature Model for a Generic VM

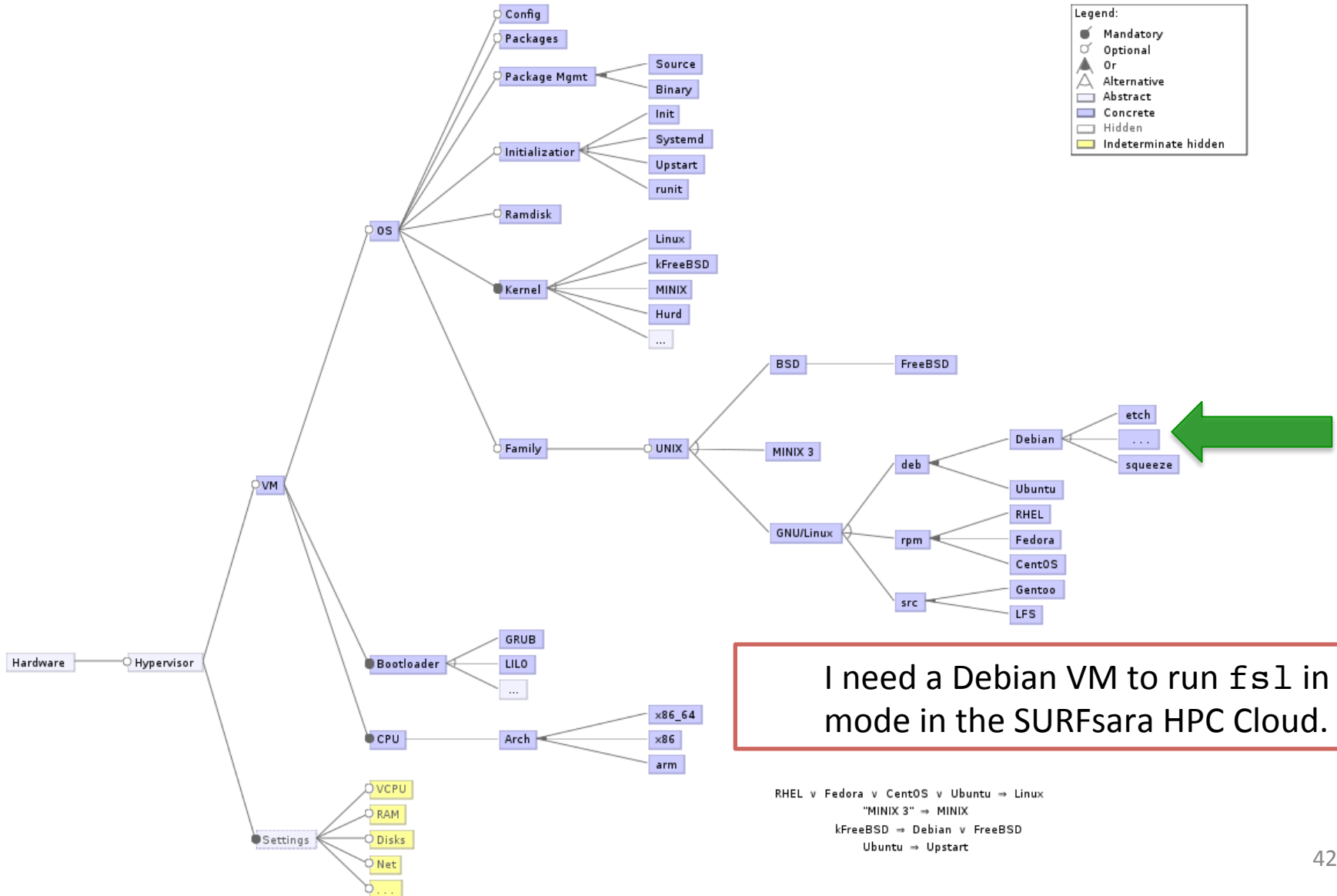

I need a Debian VM to run fs1 in text mode in the SURFsara HPC Cloud.

RHEL v Fedora v CentOS v Ubuntu → Linux
 "MINIX 3" → MINIX
 kFreeBSD ⇒ Debian v FreeBSD
 Ubuntu ⇒ Upstart

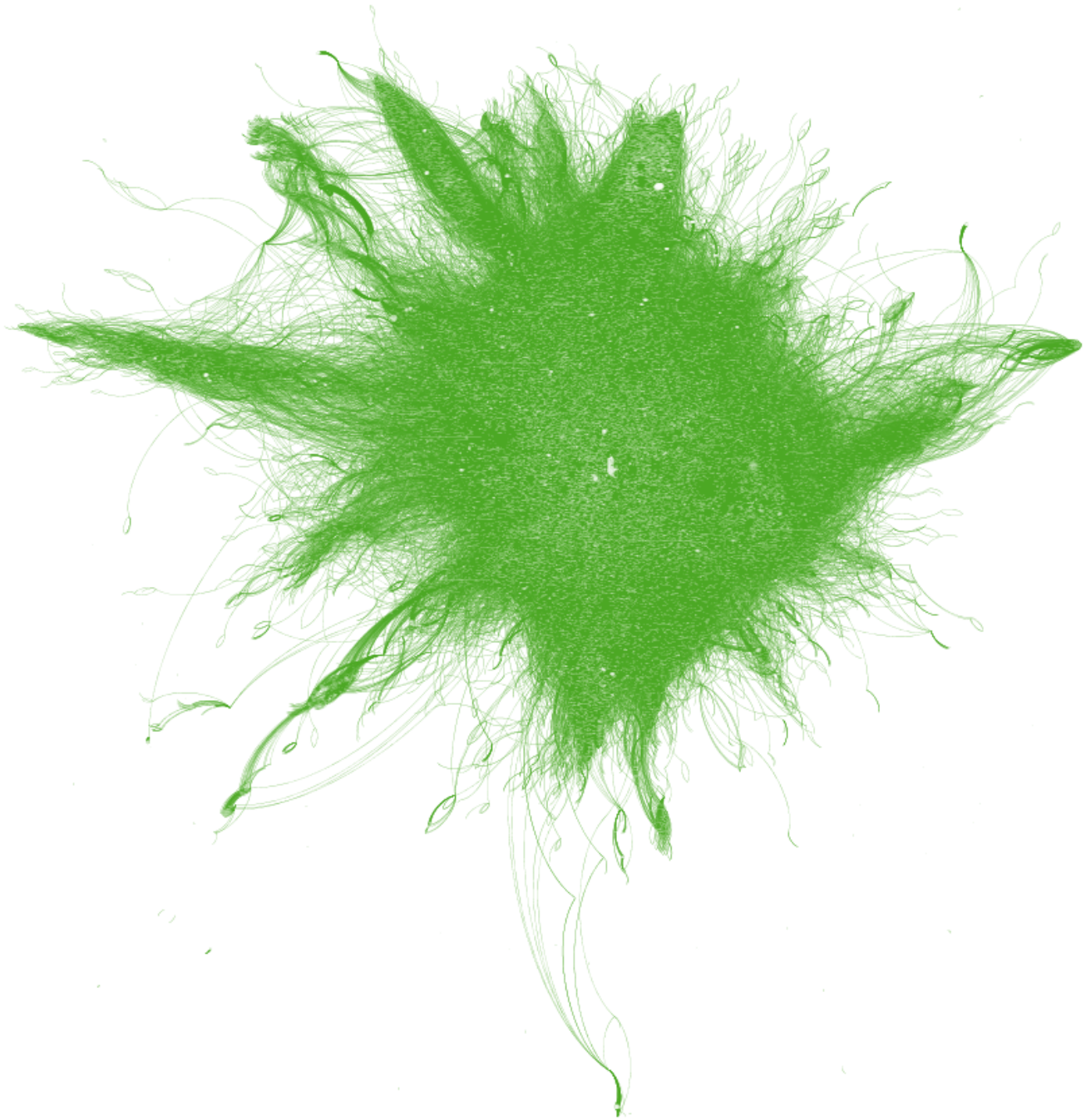

Mission

Can we create smart and safe data processing infrastructures that can be tailored to diverse application needs?

- *Capacity*
 - *Bandwidth on demand, QoS, architectures, analytics, performance*
- *Capability*
 - *Integration, virtualization, complexity, semantics, workflows*
- *Security*
 - *Anonymity, integrity of data in distributed data processing*
- *Sustainability*
 - *Greening infrastructure, awareness*
- *Resilience*
 - *Systems under attack, failures, disasters*

SMART





I want to



“Show **Big Bug Bunny** in **4K** on my **Tiled Display** using **green** Infrastructure”

- **Big Bugs Bunny** can be on multiple servers on the Internet.
 - Movie may need processing / recoding to get to **4K** for **Tiled Display**.
 - Needs deterministic **Green** infrastructure for Quality of Experience.
 - Consumer / Scientist does not want to know the underlying details.
- His refrigerator also just works!

TimeLine

-  we started this
-  we strongly participated
-  we use

 GreenIT&Nets

 SF for Clouds

 NDL SF for complex nets

 Programmable Networks  NetApp's

 CineGrid  SF for CineGrid

 NM  OCCI  NSI

 LightPaths - GLIF  Hybrid Nets

 RDUDP, SCTCP, ... 

 AAA  TBN  Policy

 ATM  SONET/SDH (G)MPLS  PBT/PLSB  OpenFlow

 TCP  TCP Reno, Vegas

1980 1990 2000 2005 2012

TimeLine

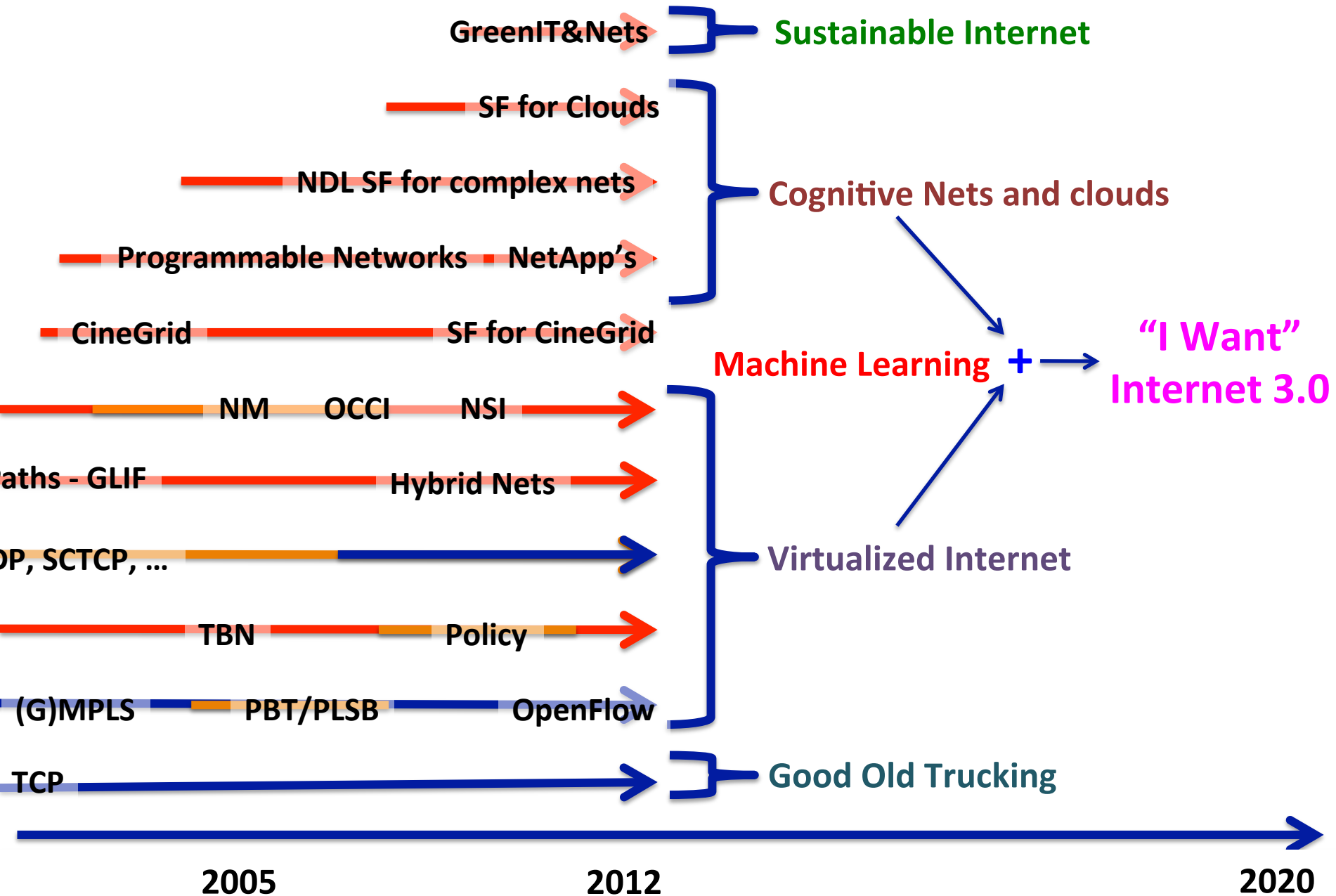

TimeLine

• Sustainable Internet

• Cognitive Nets and clouds

• Machine Learning +

• Virtualized Internet

• Good Old Trucking

“I Want”
Internet 3.0



I
retire

2020

2040

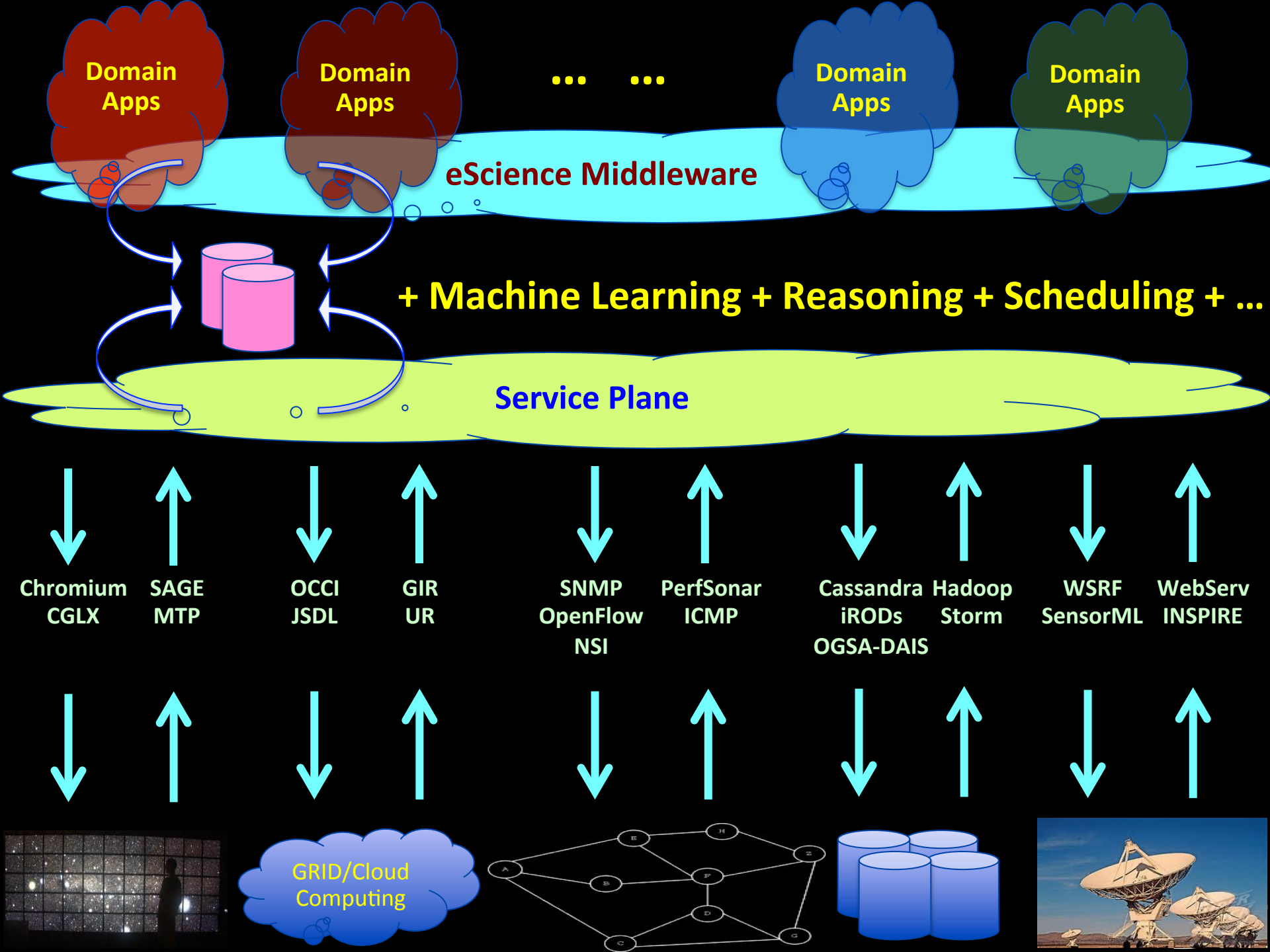

RDF describing Infrastructure

“I want”

Application: find video containing x,
then trans-code to it view on Tiled Display

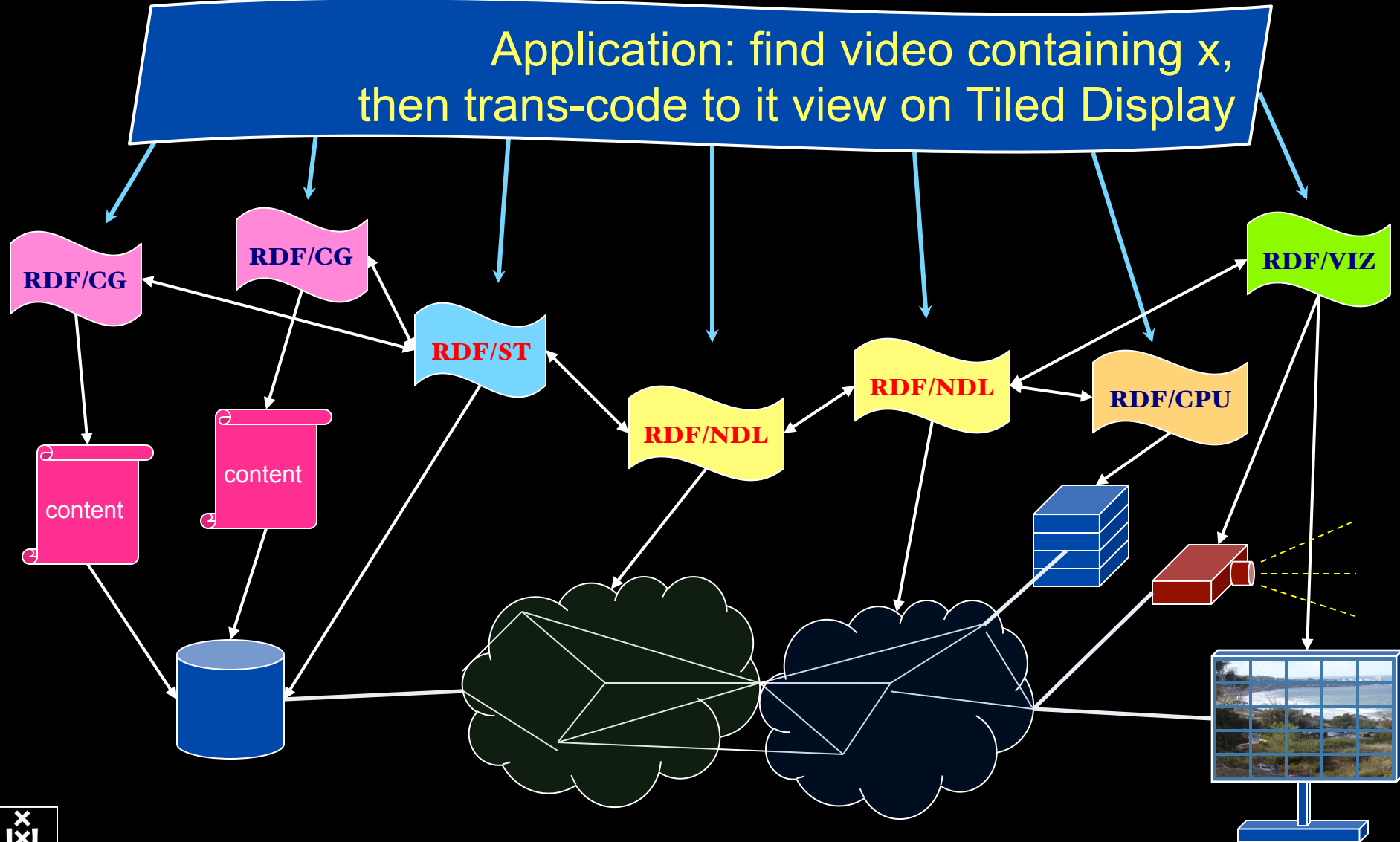

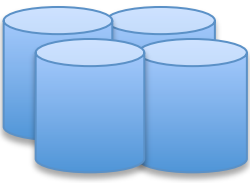
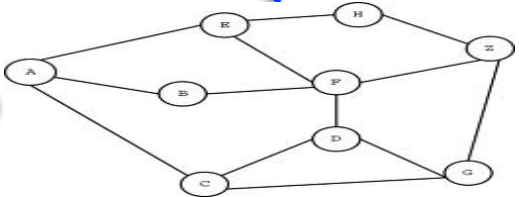
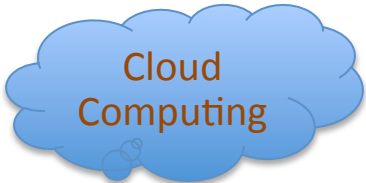
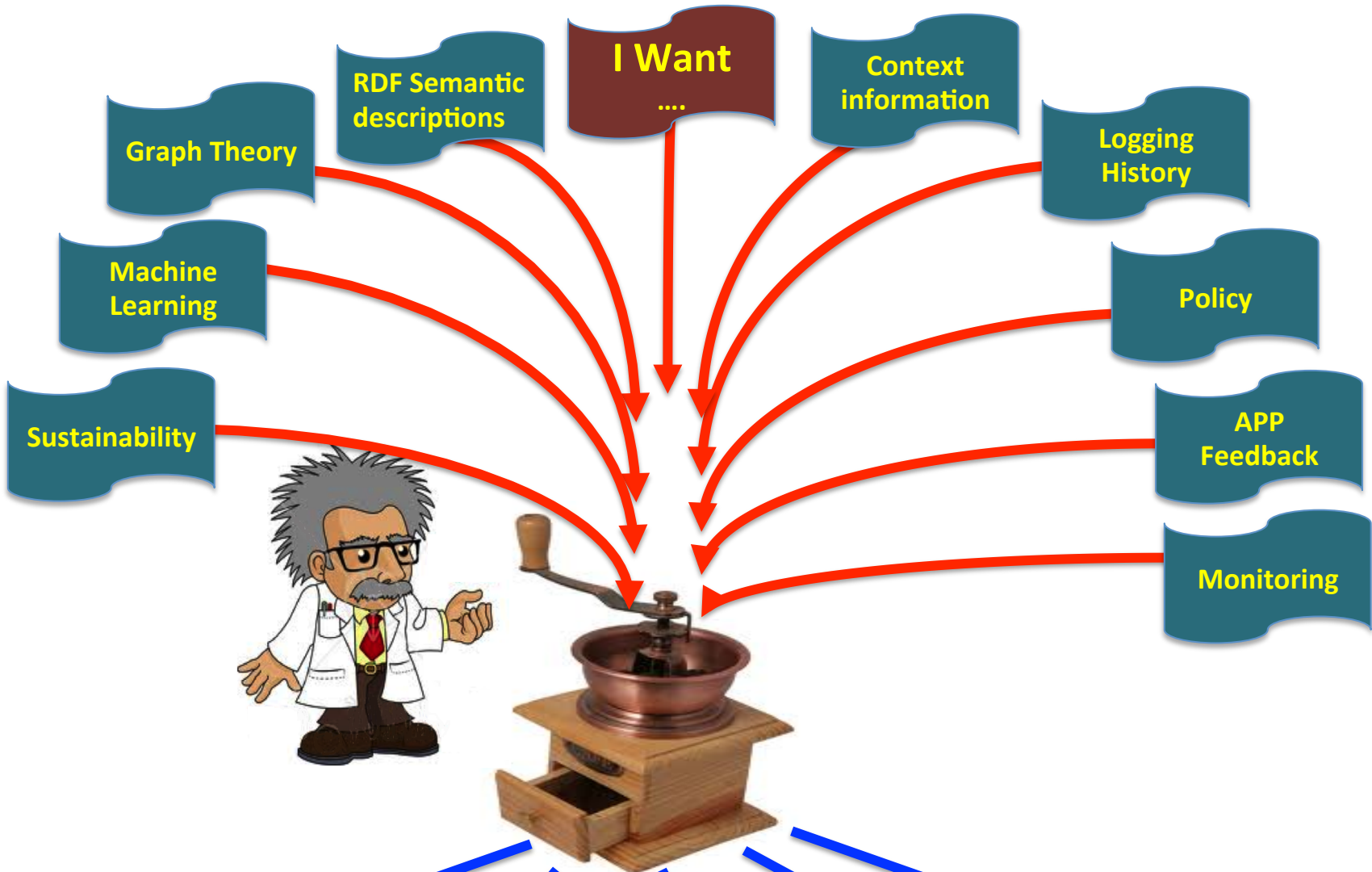

Conclusion

I want a MiS system!

Catchphrase first used in "Encounter At Farpoint" (28 September 1987) by Gene Roddenberry, and thereafter used in many episodes and films, instructing a crew member to execute an order.



The constant factor in our field is Change!

The 50 years it took Physicists to find one particle, the Higgs,
we came from:

Assembler, Fortran, COBOL, VM, RSX11, Unix, c, Pascal,
SmallTalk, DECnet, VMS, TCP/IP, c++, Internet, WWW,
ATM, Semantic Web, Photonic networks, Google, Grid,
Phyton, FaceBook, Twitter, Cloud, SDN, Data³, App's

to:

DDOS attacks destroying Banks and BitCoins!

Conclusion:

Need for Safe, Smart, Resilient Sustainable Infrastructure.

Research direction

- Control of Infrastructure
- Information on Infrastructure
- Virtualization
- Networked data processing
- Sustainability & Complexity

Events on the horizon

- I4DW & DSRC
 - Launch Nov 13
- PIRE & OpenScienceDataCloud.org
 - Workshop June 2014 @ UvA
- Research Data Alliance
 - Conference in Amsterdam Sept 2014



Questions?

Arie Taal
Paola Grosso Ana Oprescu
Cees de Laat Marc Makkes Ralph Koning
Bas Terwijn Leon Gommans Fahimeh Alizadeh
Pieter Adriaans Cosmin Dumitru Karst Koymans
Yuri Demchenko Rob Meijer Karel van der Veldt
Rudolf Strijkers Miroslav Zivkovic Reggie Cushing
Naod Duga Jebessa Spiros Koulouzis Hao Zhu Jan Sipke van der Veen
Jaap van Ginkel Guido van 't Noordende Sander Klous
Jeroen van der Ham
Mikolaj Baranowski Steven de Rooij
Ngo Tong Canh Souley Madougou Paul Klint
Adianto Wibisono Magiel Bruntink
Zhiming Zhao Anna Varbanescu Marijke Kaat
Niels Sijm Hans Dijkman Gerben de Vries
Adam Belloum Arno Bakker Marian Bubak
Daniel Romao Erik-Jan Bos
Peter Bloem

<http://sne.science.uva.nl>

<http://www.os3.nl/>

<http://i4dw.nl/>

<http://dsrc.nl/>

<http://sne.science.uva.nl/openlab/>

<http://pire.opensciencedatacloud.org>

<http://staff.science.uva.nl/~delaat/pire/>

<https://rd-alliance.org>



Trip supported by:

