



# From King's Dutch Academy of Sciences The Dutch Research Agenda

“Information technology (IT) now permeates all aspects of public, commercial, social, and personal life. bank cards, satnav, and weather radar... IT has become completely indispensable.”

“But to **guarantee** the **reliability** and **quality** of constantly **bigger** and more **complicated** IT, we will need to find answers to some **fundamental questions!**”





# Reduction of Complexity by Integration

By combining services such as telephony, television, data, and computing capacity within a single network, we can cut down on complexity, energy consumption and maintenance.

- How can we describe and analyze complex information systems effectively?
- How can we specify and measure the quality and reliability of a system?
- How can we combine various different systems?
- How can we design systems in which separate processors can co-operate efficiently via mutual network connections within a much larger whole?
- Can we design information systems that can diagnose their own malfunctions and perhaps even repair them?
- How can we specify, predict, and measure system performance as effectively as possible?

SNE addresses a.o. the highlighted questions!

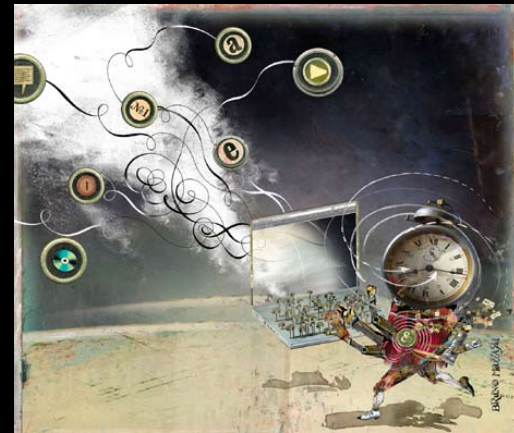

# Mission

*Can we create smart and safe data processing infrastructures that can be tailored to diverse application needs?*

- *Capacity*
- *Capability*
- *Security*
- *Sustainability*
- *Resilience*



# Mission

*Can we create smart and safe data processing infrastructures that can be tailored to diverse application needs?*

- *Capacity*
  - *Bandwidth on demand, QoS, architectures, photonics, performance*
- *Capability*
  - *Programmability, virtualization, complexity, semantics, workflows*
- *Security*
  - *Anonymity, integrity of data in distributed data processing*
- *Sustainability*
  - *Greening infrastructure, awareness*
- *Resilience*
  - *Systems under attack, failures, disasters*



# Mission

*Can we create smart and safe data processing infrastructures that can be tailored to diverse application needs?*

- **Capacity**
  - *Bandwidth on demand, QoS, architectures, photonics, performance*
- **Capability**
  - *Programmability, virtualization, complexity, semantics, workflows*
- **Security**
  - *Anonymity, integrity of data in distributed data processing*
- **Sustainability**
  - *Greening infrastructure, awareness*
- **Resilience**
  - *Systems under attack, failures, disasters*





# ATLAS detector @ CERN Geneve

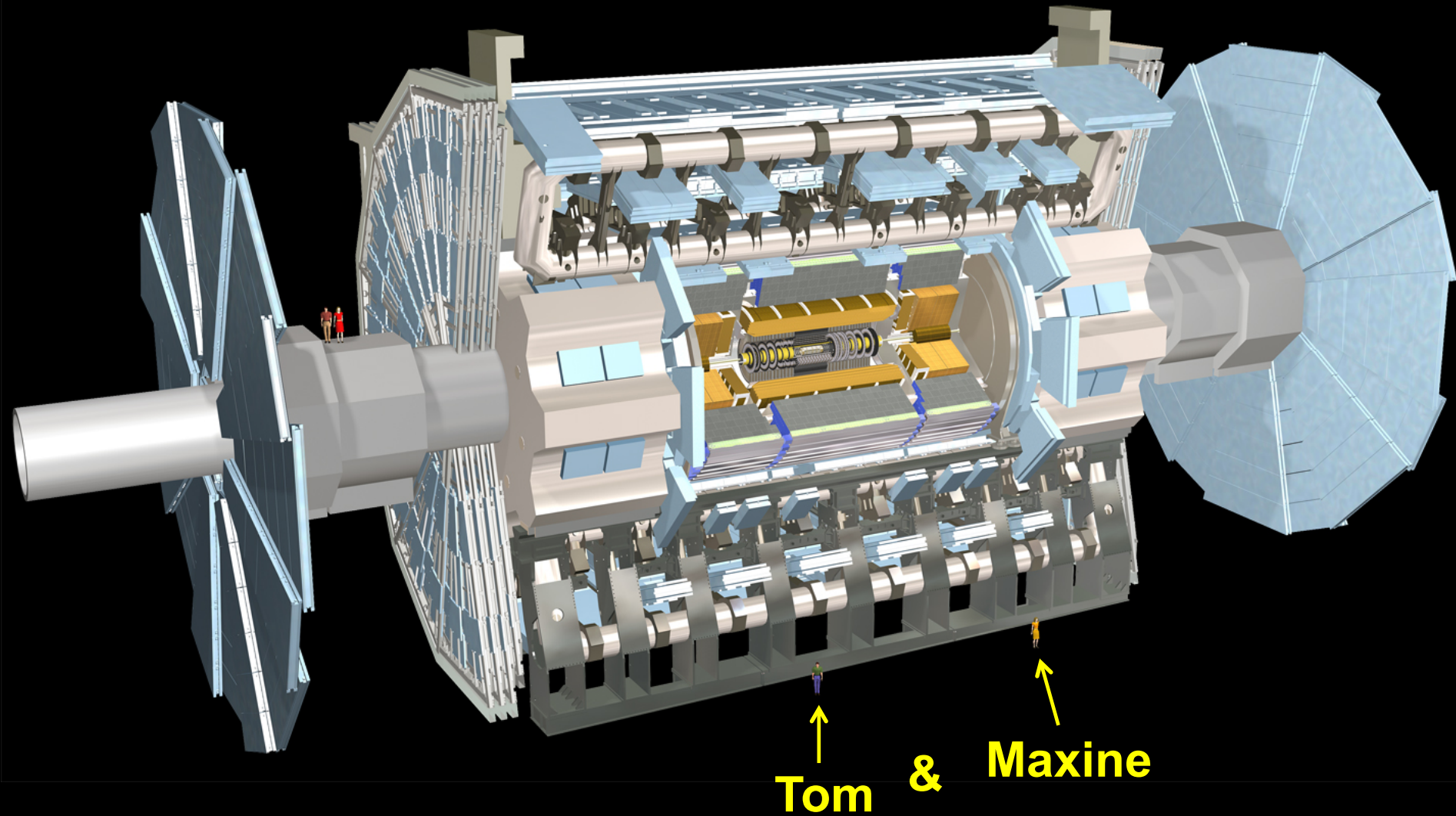

# What Happens in an Internet Minute?



## And Future Growth is Staggering





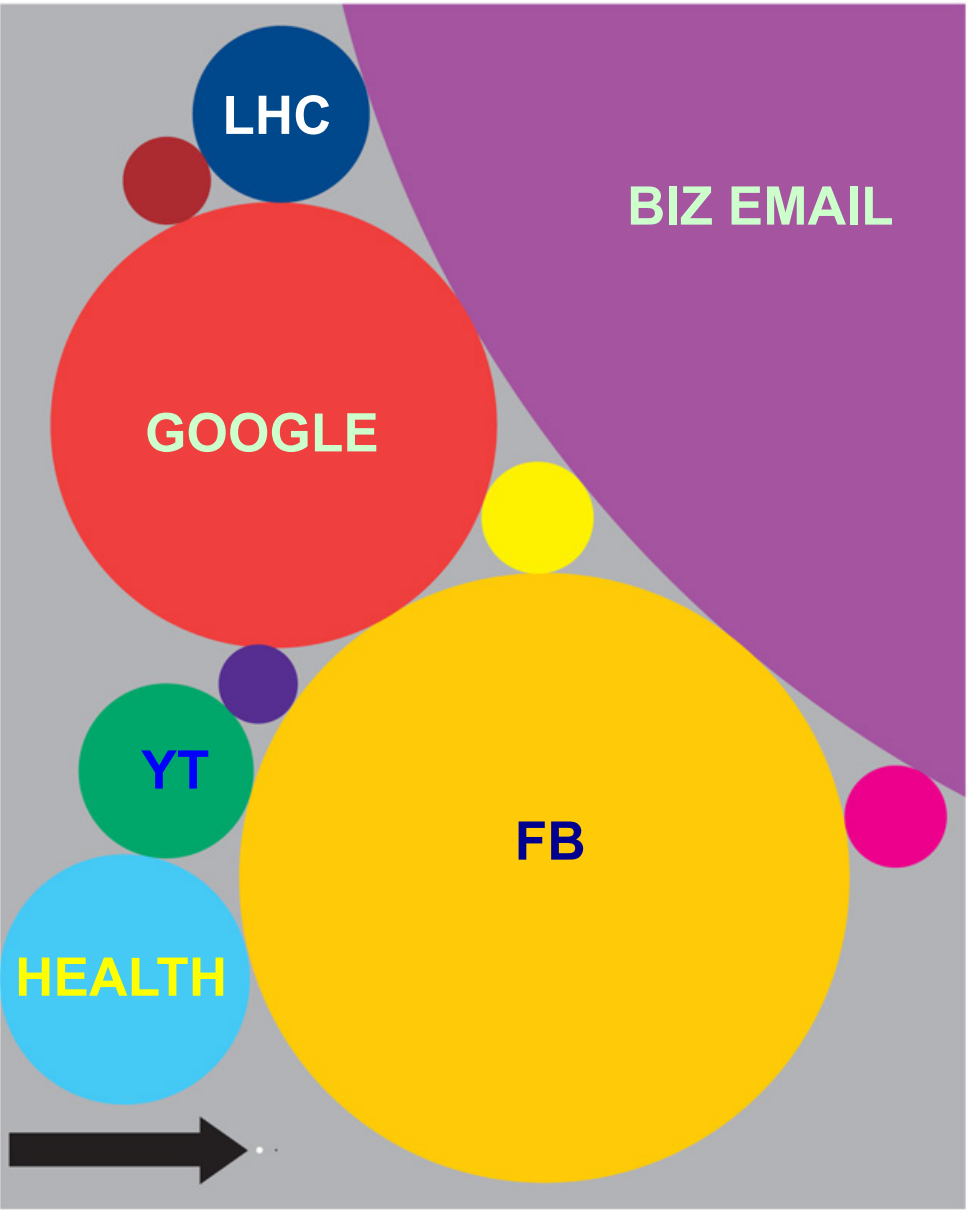

There  
is  
always  
a  
bigger  
fish

Size of data sets in terabytes

Business email sent per year	2,986,100	National Climactic Data Center database	6,144
Content uploaded to Facebook each year	182,500	Library of Congress' digital collection	5,120
Google's search index	97,656	US Census Bureau data	3,789
Kaiser Permanente's digital health records	30,720	Nasdaq stock market database	3,072
Large Hadron Collider's annual data output	15,360	Tweets sent in 2012	19
Videos uploaded to YouTube per year	15,000	Contents of every print issue of WIRED	1.26

... more data!

# Internet developments

Google

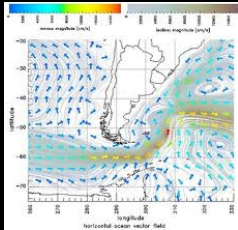

DATA

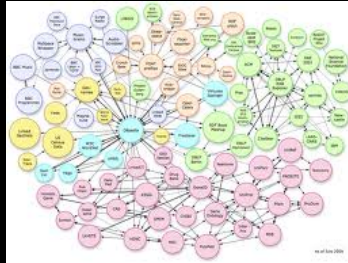

... more realtime!



twitter



myspace  
a place for freedom



Linked in



SchoolBANK

Hyves

flickr  
from YAHOO!



... more users!





... more data!

Internet developments

Google

Speed  
Volume

DATA

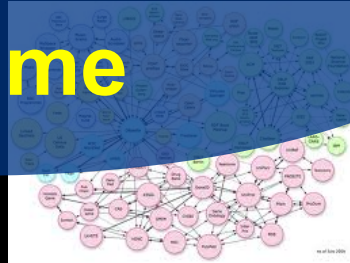
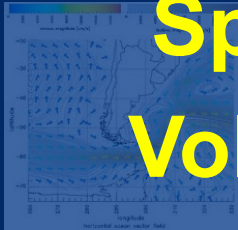

Deterministic

Real-time



twitter



Scalable

Secure

LinkedIn



myspace  
SchoolBANK

Hyves

flickr  
from YAHOO!



... more users!



# Multiple colors / Fiber

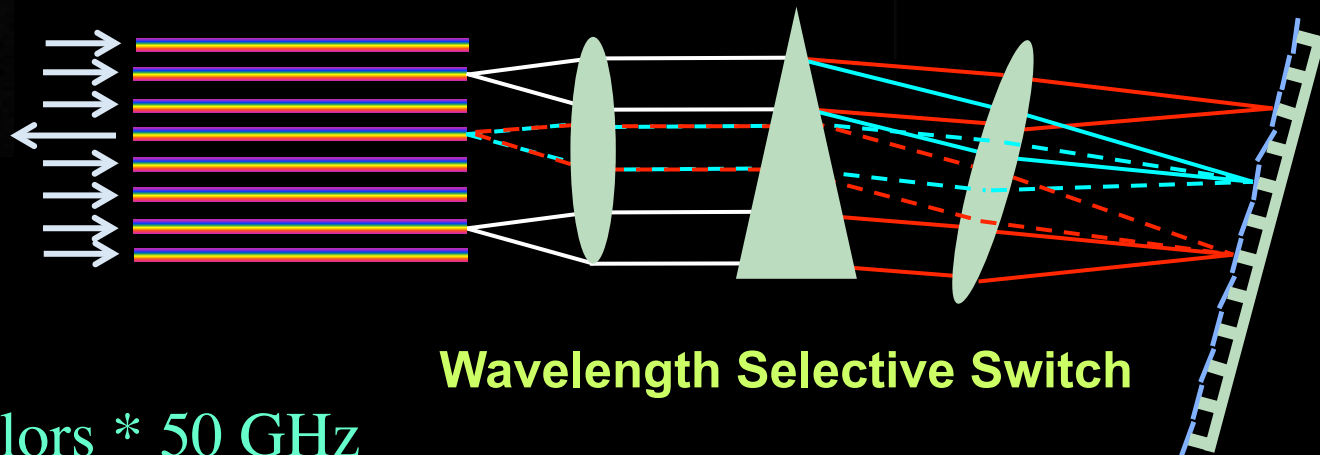
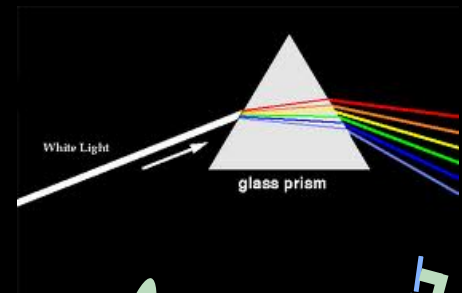
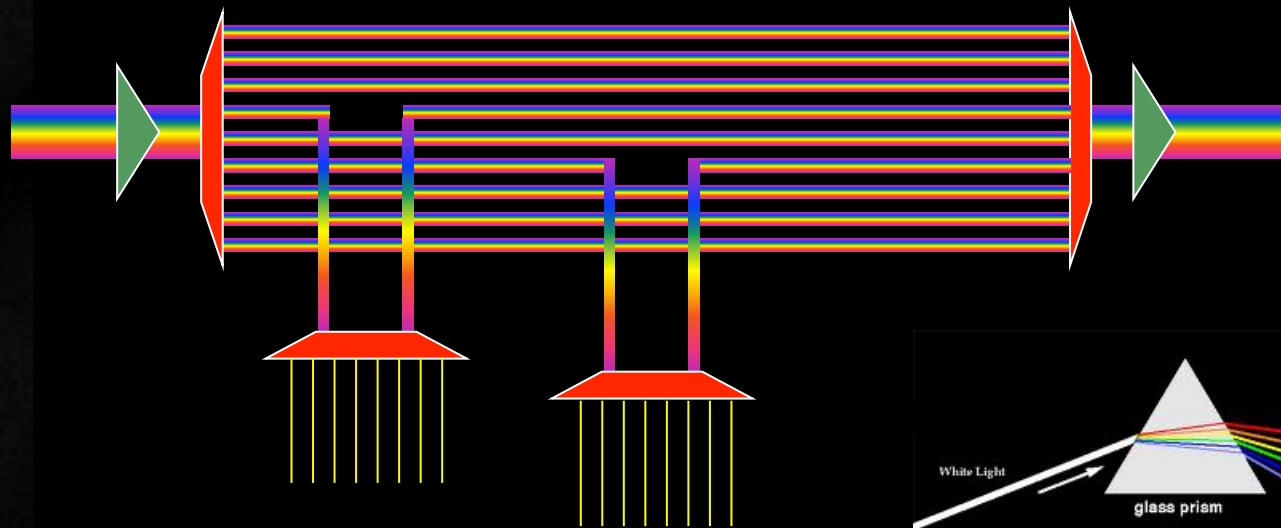

**Wavelength Selective Switch**

Per fiber:  $\sim 80-100$  colors \* 50 GHz

Per color: 10 – 40 – 100 Gbit/s

BW \* Distance  $\sim 2 * 10^{17}$  bm/s

New: Hollow Fiber!

→ less RTT!



# Wireless Networks

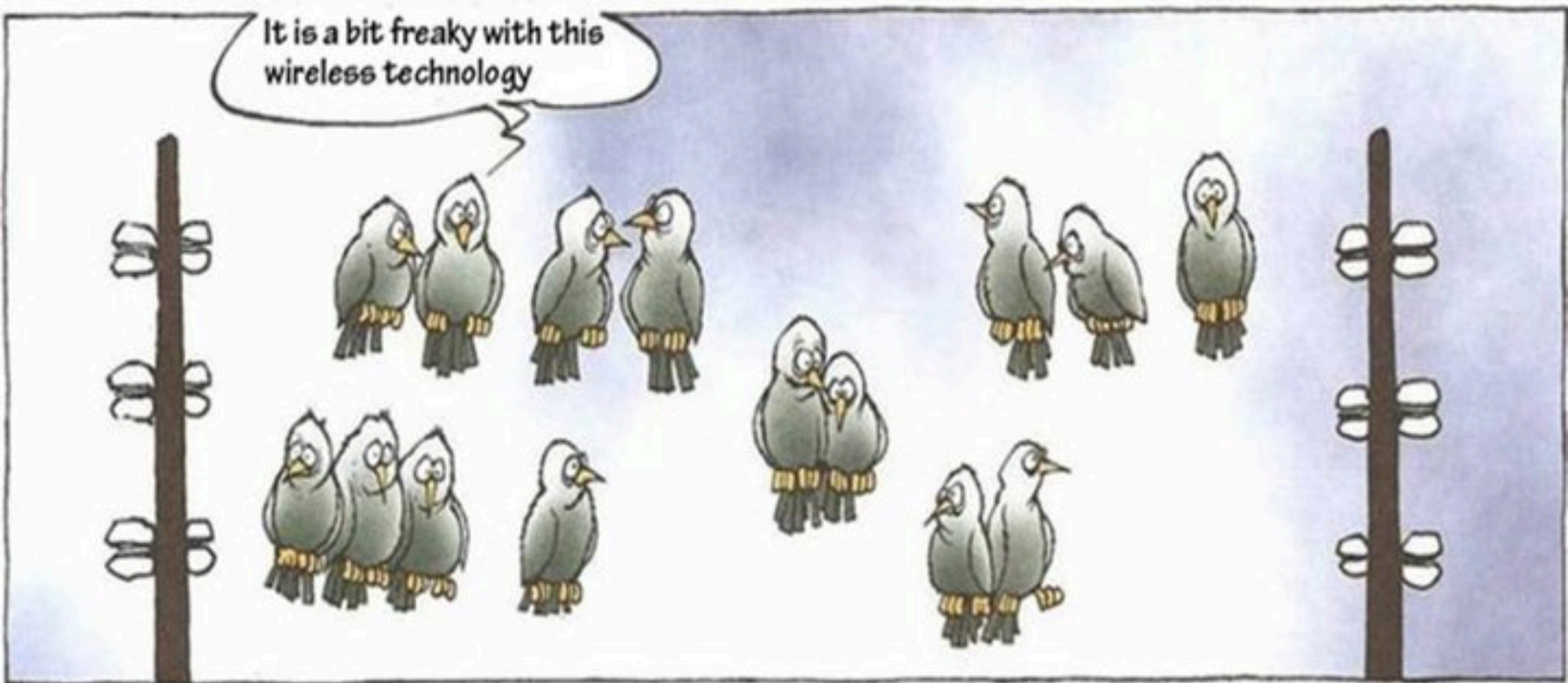

COPYRIGHT : MORTEN INGEMANN

protocol LAN due to the easy comparison and convenience in the **digital home**. While consumer PC products has just started to migrate to a much higher bandwidth of 802.11n wireless LAN now working on next-generation standard definition is already in progress.



# GPU cards are disruptive!

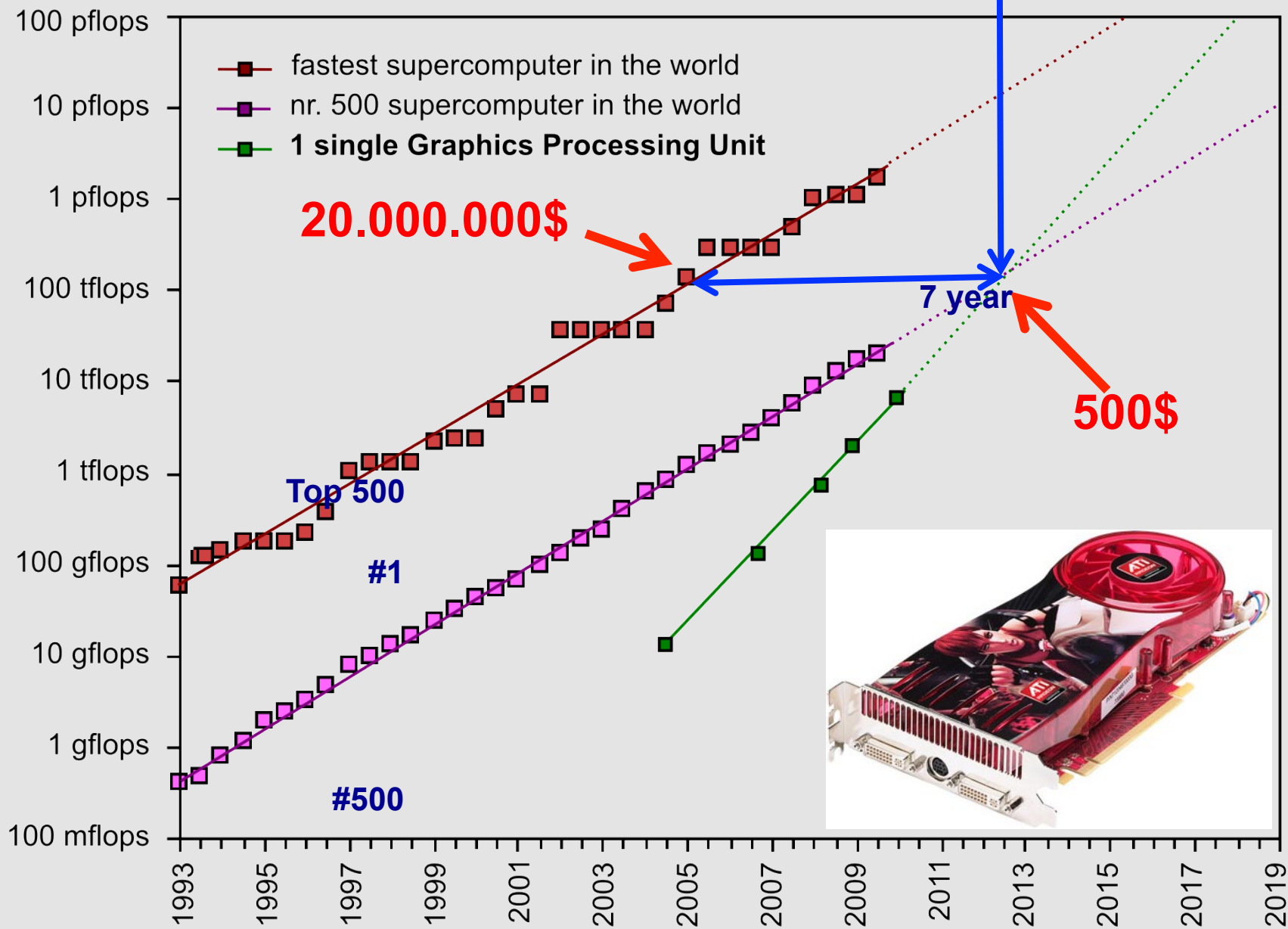



# Reliable and Safe!

This omnipresence of IT makes us not only strong but also vulnerable.

- A virus, a hacker, or a system failure can instantly send digital shockwaves around the world.

The hardware and software that allow all our systems to operate is becoming bigger and more complex all the time, and the capacity of networks and data storage is increasing by leaps and bounds.

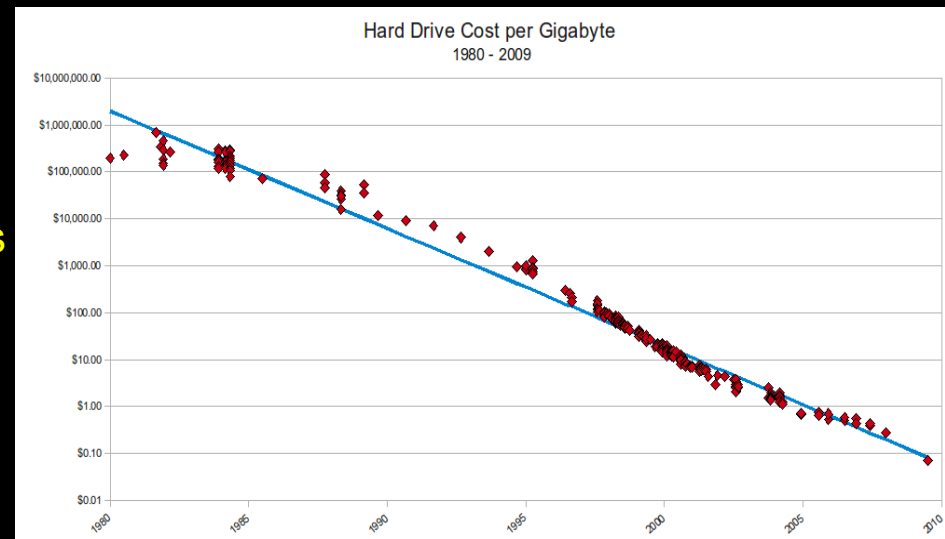

We will soon reach the limits of what is currently feasible and controllable.

## Performance Development

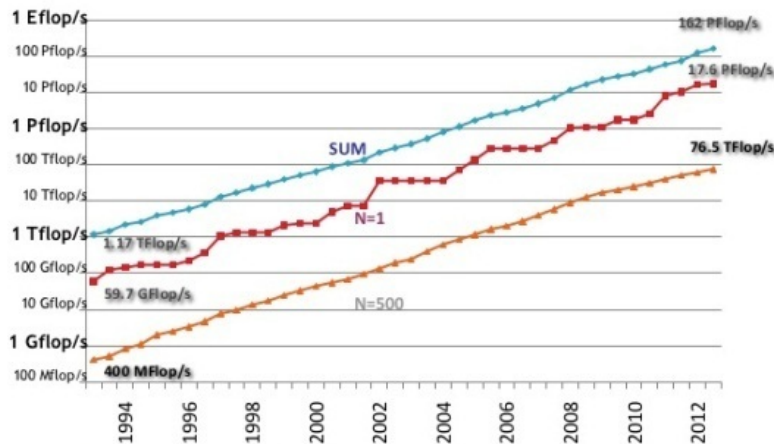











# ExoGeni @ OpenLab - UvA

Installed and up June 3th 2013



Connected via the new 100 Gb/s transatlantic To US-GENI

## TNC2013 DEMOS JUNE, 2013

DEMO	TITLE	OWNER	AFFILIATION	E-MAIL	A-SIDE	Z-SIDE	PORTS(S) MAN LAN	PORTS(S) TNC2013	DETAILS
1	Big data transfers with multipathing, OpenFlow and MPTCP	Ronald van der Pol	SURFnet	ronald.vanderpol@surfnet.nl	TNC/MECC, Maastricht NL	Chicago, IL	Existing 100G link between internet2 and ESnet	2x40GE (Juniper)-2x10GE (OME6500)	In this demonstration we show how multipathing, OpenFlow and Multipath TCP (MPTCP) can help in large file transfers between data centres (Maastricht and Chicago). An OpenFlow application provisions multiple paths between the servers and MPTCP will be used on the servers to simultaneously send traffic across all these paths. This demo uses 2x40GE on the transatlantic 100G link. ESnet provides 2x40G between MAN LAN and StarLight, ACE and USLight provide additional 10GEs.
2	Visualize 100G traffic	Inder Monga	ESnet	imonga@es.net					Using an SNMP feed from the Juniper switch at TNC2013 and/or Brocade AL25 node in MANLAN, this demo would visualize the total traffic on the link, of all demos aggregated. The network diagram will show the transatlantic topology and some of the demo topologies.
3	How many modern servers can fill a 100Gbps Transatlantic Circuit?	Inder Monga	ESnet	imonga@es.net	Chicago, Ill	TNC showfloor	1x 100GE	8x 10GE	In this demonstration, we show that with the proper tuning and test, only 2 hosts on each continent can generate almost 80Gbps of traffic. Each server has 4 10G NICs connected to a 40G virtual circuit, and has perf3 running to generate traffic. ESnet's new 'perf3' throughput measurement tool, still in beta, combines the best features from other tools such as perf, netperf, and netperf. See: https://my.surfnet.nl/demos/tnc2013/
4	First European ExoGeni at Work	Jeroen van der Ham	UvA	vdham@uva.nl	RENCI, NC	UvA, Amsterdam, NL	1x 10GE	1x 10GE	The ExoGENI racks at RENC1 and UvA will be interconnected over a 100 pipe and be on continuously, showing GENI connectivity between Amsterdam and the rest of the GENI nodes in the USA.
5	Up and down North Atlantic @ 100G	Michael Enrico	DANTE	michael.enrico@dante.net	TNC showfloor	TNC showfloor	1x 100GE	1x 100GE	The DANTE 100GE test set will be placed at the TNC2013 showfloor and connected to the Juniper at 100G. When this demo is running a loop @ MAN LAN's Brocade switch will ensure that the traffic sent to MAN LAN returns to the showfloor. On display is the throughput and RTT (to show the traffic travelled the Atlantic twice)



# Alien light From idea to realisation!

## 40Gb/s alien wavelength transmission via a multi-vendor 10Gb/s DWDM infrastructure



### Alien wavelength advantages

- Direct connection of customer equipment<sup>[1]</sup> → cost savings
- Avoid OEO regeneration → power savings
- Faster time to service<sup>[2]</sup> → time savings
- Support of different modulation formats<sup>[3]</sup> → extend network lifetime

### Alien wavelength challenges

- Complex end-to-end optical path engineering in terms of linear (i.e. OSNR, dispersion) and non-linear (FWM, SPM, XPM, Raman) transmission effects for different modulation formats.
- Complex interoperability testing.
- End-to-end monitoring, fault isolation and resolution.
- End-to-end service activation.

In this demonstration we will investigate the performance of a 40Gb/s PM-QPSK alien wavelength installed on a 10Gb/s DWDM infrastructure.

### New method to present fiber link quality, FoM (Figure of Merit)

In order to quantify optical link grade, we propose a new method of representing system quality: the FOM (Figure of Merit) for concatenated fiber spans.

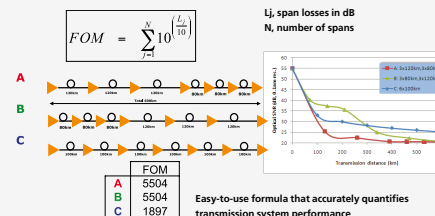

### Transmission system setup

JOINT SURFnet/NORDUnet 40Gb/s PM-QPSK alien wavelength DEMONSTRATION.

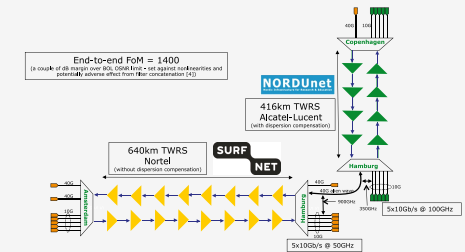

### Test results

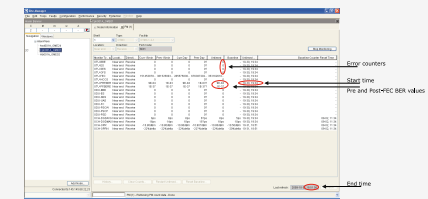

Error-free transmission for 23 hours, 17 minutes → BER < 3,0 10<sup>-16</sup>

### Conclusions

- We have investigated experimentally the all-optical transmission of a 40Gb/s PM-QPSK alien wavelength via a concatenated native and third party DWDM system that both were carrying live 10Gb/s wavelengths.
- The end-to-end transmission system consisted of 1056 km of TWRS (TrueWave Reduced Slope) transmission fiber.
- We demonstrated error-free transmission (i.e. BER below 10<sup>-15</sup>) during a 23 hour period.
- More detailed system performance analysis will be presented in an upcoming paper.



REFERENCES  
ACKNOWLEDGEMENTS

[1] "OPERATIONAL SOLUTIONS FOR AN OPEN DWDM LAYER", O. GERSTEL ET AL. OFC2009 | [2] "AT&T OPTICAL TRANSPORT SERVICES", BARBARA E. SMITH, OFC'09  
 [3] "OPEX SAVINGS OF ALL-OPTICAL CORE NETWORKS", ANDREW LORD AND CARL ENGINEER, ECCO2009 | [4] NORTEL/SURFNET INTERNAL COMMUNICATION  
 WE ARE GRATEFUL TO NORDUNET FOR PROVIDING US WITH BANDWIDTH ON THEIR DWDM LINK FOR THIS EXPERIMENT AND ALSO FOR THEIR SUPPORT AND ASSISTANCE DURING THE EXPERIMENTS. WE ALSO ACKNOWLEDGE TELINDUS AND NORTEL FOR THEIR INTEGRATION WORK AND SIMULATION SUPPORT



# Alien light From idea to realisation!

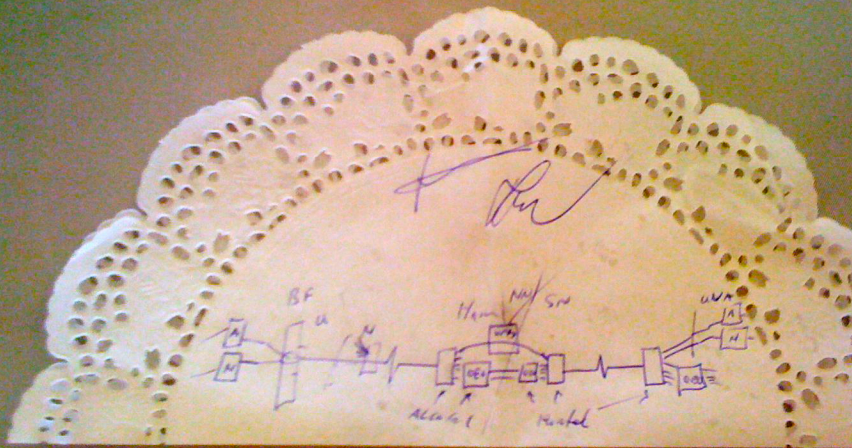

## 40Gb/s alien wavelength transmission via a multi-vendor 10Gb/s DWDM infrastructure



### Alien wavelength advantages

- Direct connection of customer equipment<sup>[1]</sup> → cost savings
- Avoid OEO regeneration → power savings
- Faster time to service<sup>[2]</sup> → time savings
- Support of different modulation formats<sup>[3]</sup> → extend network lifetime

### Alien wavelength challenges

- Complex end-to-end optical path engineering in terms of linear (i.e. OSNR, dispersion) and non-linear (FWM, SPM, XPM, Raman) transmission effects for different modulation formats.
- Complex interoperability testing.
- End-to-end monitoring, fault isolation and resolution.
- End-to-end service activation.

In this demonstration we will investigate the performance of a 40Gb/s PM-QPSK alien wavelength installed on a 10Gb/s DWDM infrastructure.

### New method to present fiber link quality, FoM (Figure of Merit)

In order to quantify optical link grade, we propose a new method of representing system quality: the FOM (Figure of Merit) for concatenated fiber spans.

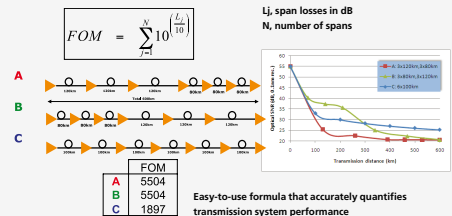

### Transmission system setup

JOINT SURFnet/NORDUnet 40Gb/s PM-QPSK alien wavelength DEMONSTRATION.

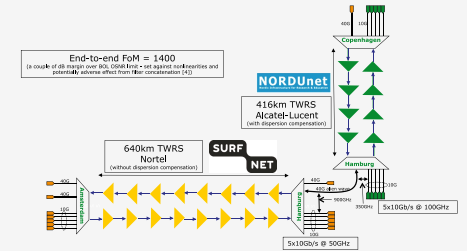

### Test results

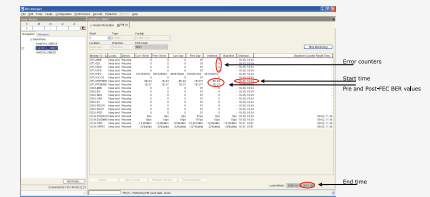

Error-free transmission for 23 hours, 17 minutes → BER < 3.0 10<sup>-16</sup>

### Conclusions

- We have investigated experimentally the all-optical transmission of a 40Gb/s PM-QPSK alien wavelength via a concatenated native and third party DWDM system that both were carrying live 10Gb/s wavelengths.
- The end-to-end transmission system consisted of 1056 km of TWRS (TrueWave Reduced Slope) transmission fiber.
- We demonstrated error-free transmission (i.e. BER below 10<sup>-15</sup>) during a 23 hour period.
- More detailed system performance analysis will be presented in an upcoming paper.



REFERENCES  
ACKNOWLEDGEMENTS

[1] "OPERATIONAL SOLUTIONS FOR AN OPEN DWDM LAYER", O. GERSTEL ET AL. OFC2009 | [2] "AT&T OPTICAL TRANSPORT SERVICES", BARBARA E. SMITH, OFC'09  
[3] "OPEX SAVINGS OF ALL-OPTICAL CORE NETWORKS", ANDREW LORD AND CARL ENGINEER, ECCO2009 | [4] NORTEL/SURFNET INTERNAL COMMUNICATION  
WE ARE GRATEFUL TO NORDUNET FOR PROVIDING US WITH BANDWIDTH ON THEIR DWDM LINK FOR THIS EXPERIMENT AND ALSO FOR THEIR SUPPORT AND ASSISTANCE DURING THE EXPERIMENTS. WE ALSO ACKNOWLEDGE TELINDUS AND NORTEL FOR THEIR INTEGRATION WORK AND SIMULATION SUPPORT



# ClearStream @ TNC2011

Setup  
codename:  
FlightCees



## UvA

iPerf  
17 3.2 GHz Q-core

iPerf  
Amd Ph II 3.6 GHz HexC

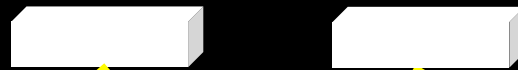

Mellanox

40G E



## Copenhagen

iPerf  
2\* dual 2.8 GHz Q-core

iPerf

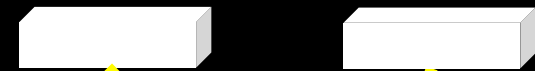

Mellanox



## CERN

CIENA DWDM

17 ms RTT

## Hamburg

Alcatel DWDM

27 ms RTT

Amsterdam – Geneva (CERN) – Copenhagen – 4400 km (2700 km alien light)

# Visit CIENA Booth

surf to <http://tnc.delat.net/tnc11>

Amsterdam (UvA) Live RX Traffic

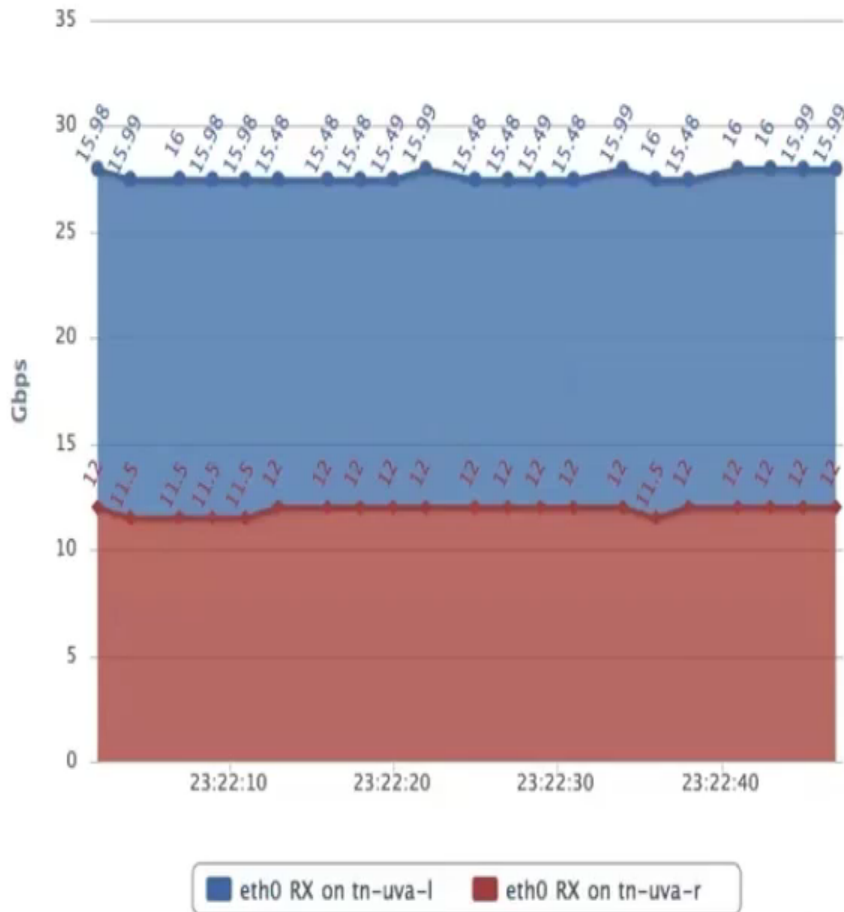

Copenhagen POP RX Traffic

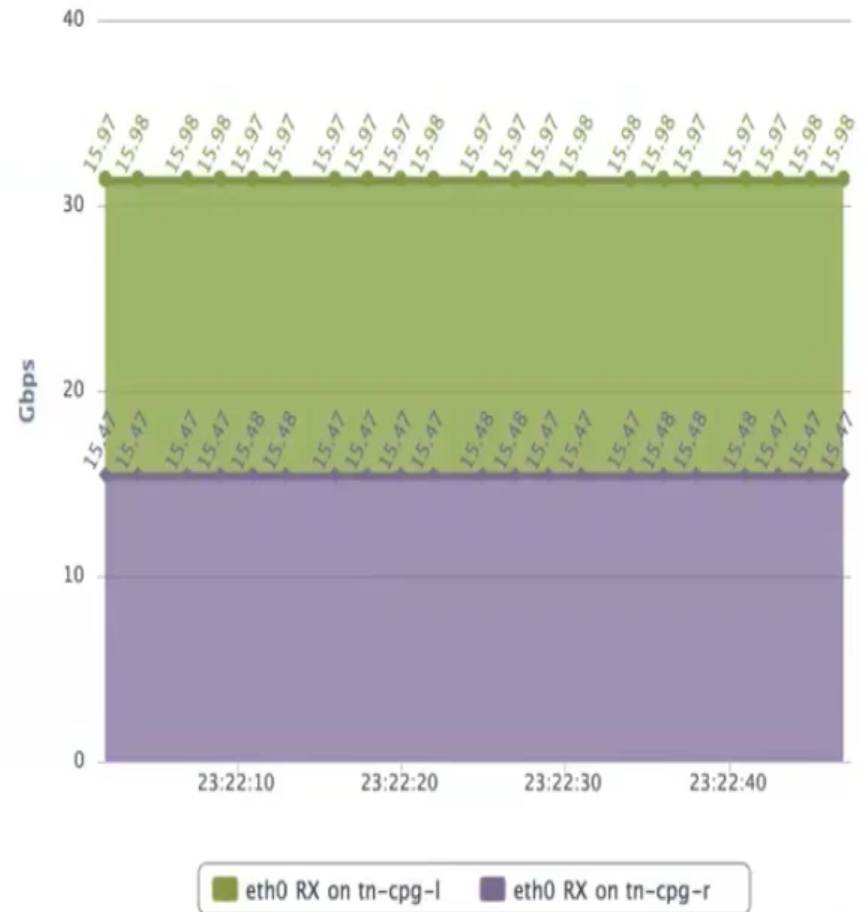

27.99 Gbps to Amsterdam <-> 31.45 Gbps to Copenhagen

Total Throughput **59.44 Gbps** RTT **44.010 ms**

# Server Architecture

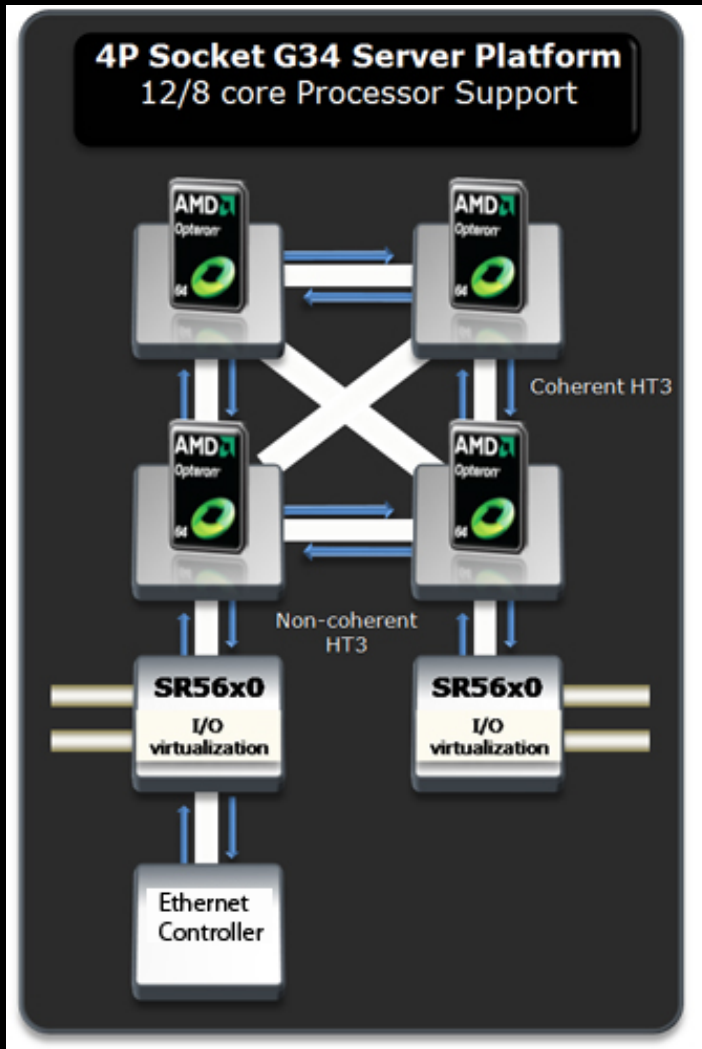

DELL R815

4 x AMD Opteron 6100

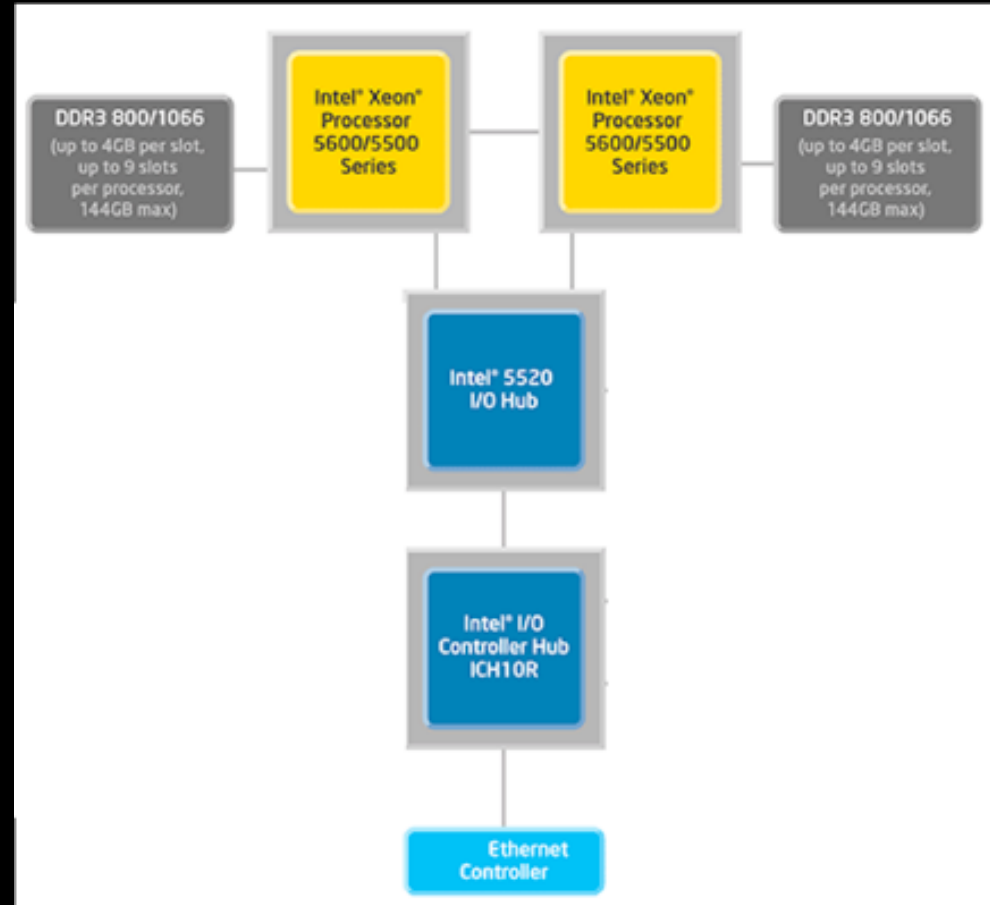

Supermicro X8DTT-HIBQF

2 x Intel Xeon

# CPU Topology benchmark

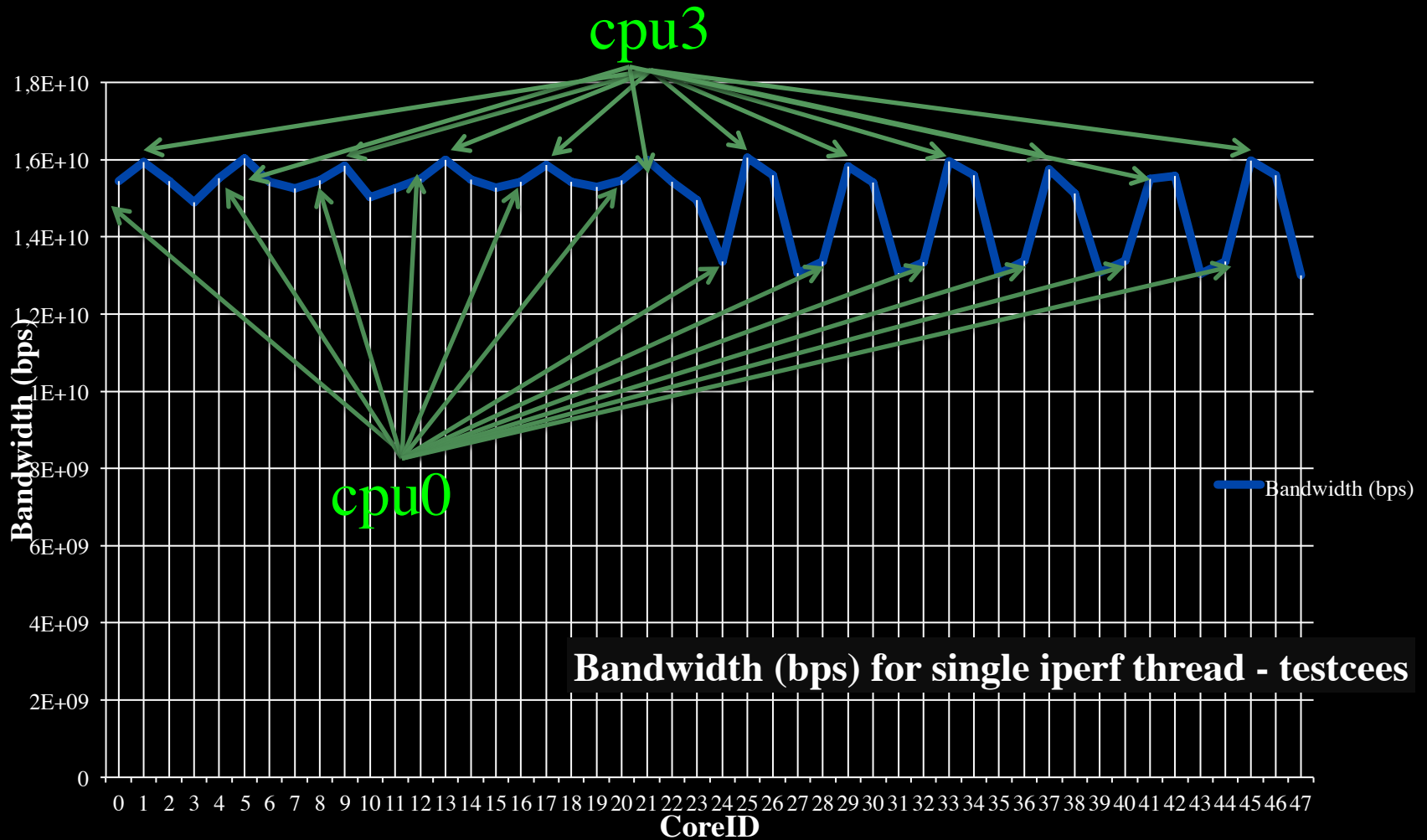

We used numactl to bind iperf to cores



# Mission

*Can we create smart and safe data processing infrastructures that can be tailored to diverse application needs?*

- *Capacity*
  - *Bandwidth on demand, QoS, architectures, photonics, performance*
- ***Capability***
  - ***Programmability, virtualization, complexity, semantics, workflows***
- *Security*
  - *Anonymity, integrity of data in distributed data processing*
- *Sustainability*
  - *Greening infrastructure, awareness*
- *Resilience*
  - *Systems under attack, failures, disasters*



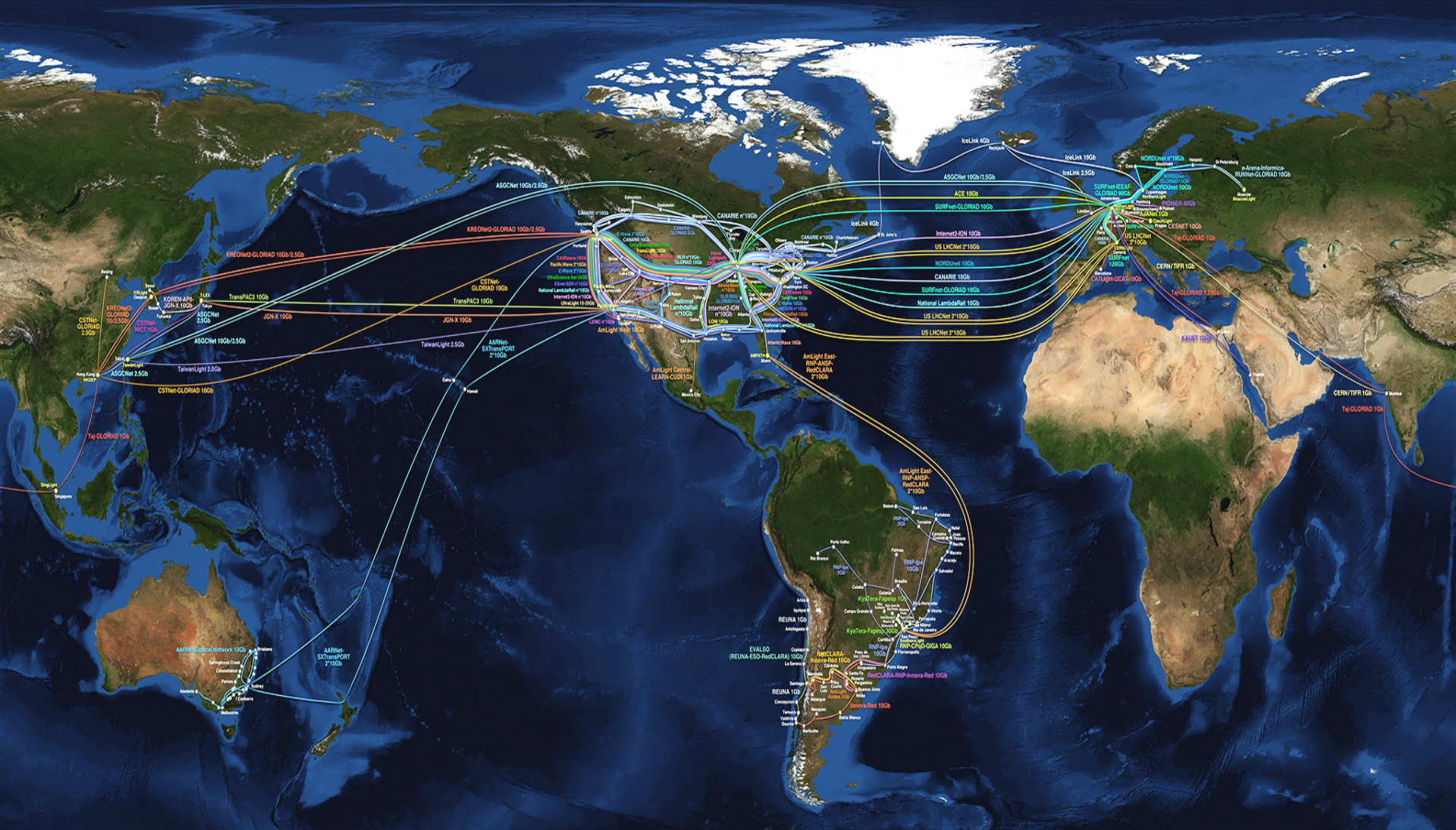

We investigate:  
 complex networks!



for







# LinkedIn for Infrastructure



- From semantic Web / Resource Description Framework.
- The RDF uses XML as an interchange syntax.
- Data is described by triplets (Friend of a Friend):

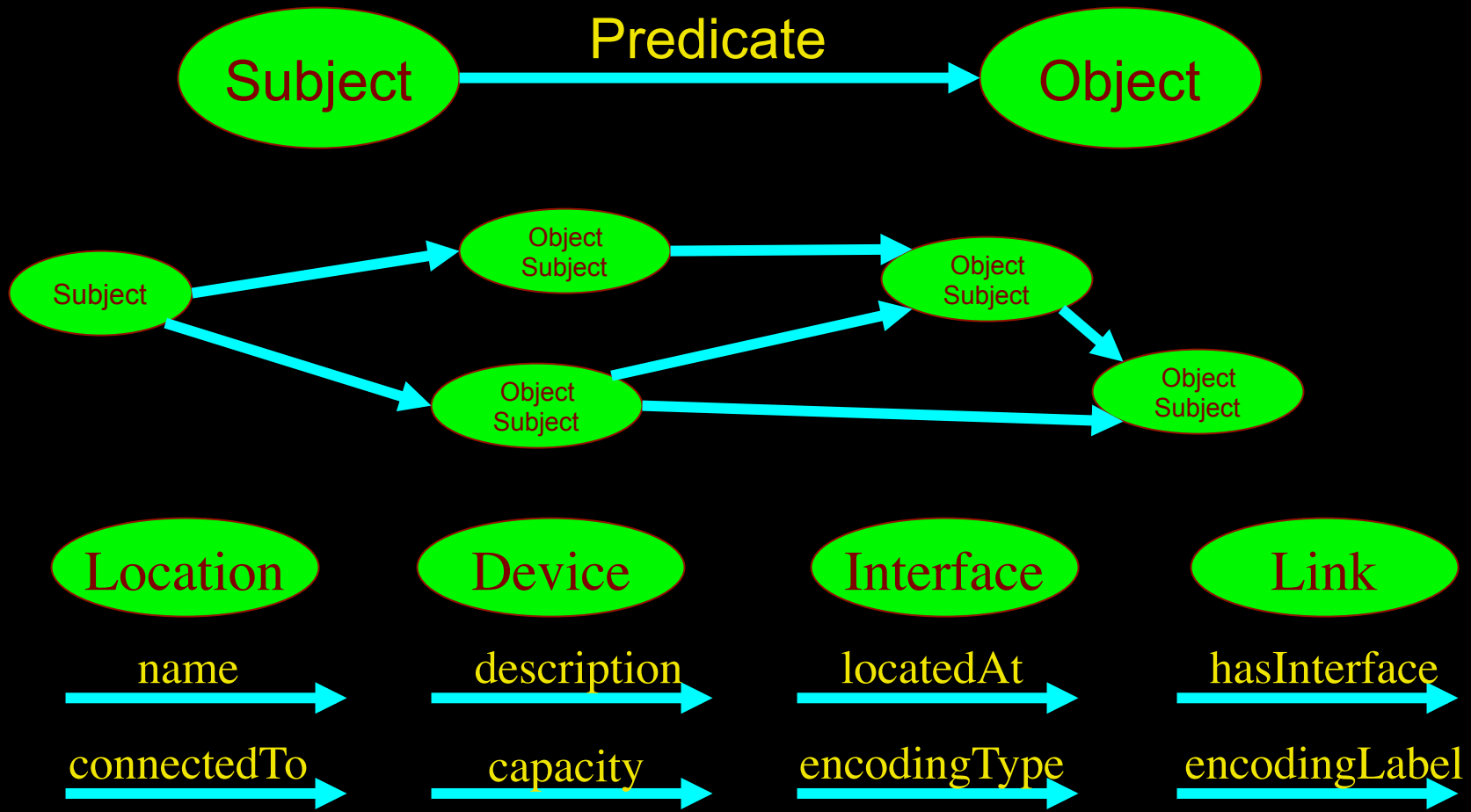



# Network Description Language

Article: F. Dijkstra, B. Andree, K. Koymans, J. van der Ham, P. Grosso, C. de Laat, "A Multi-Layer Network Model Based on ITU-T G.805"

Choice of RDF instead of XML syntax

Grounded modeling based on G805 description:

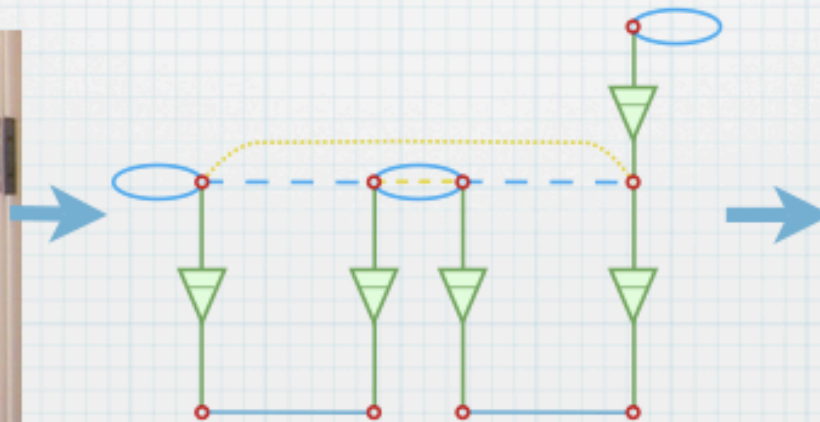
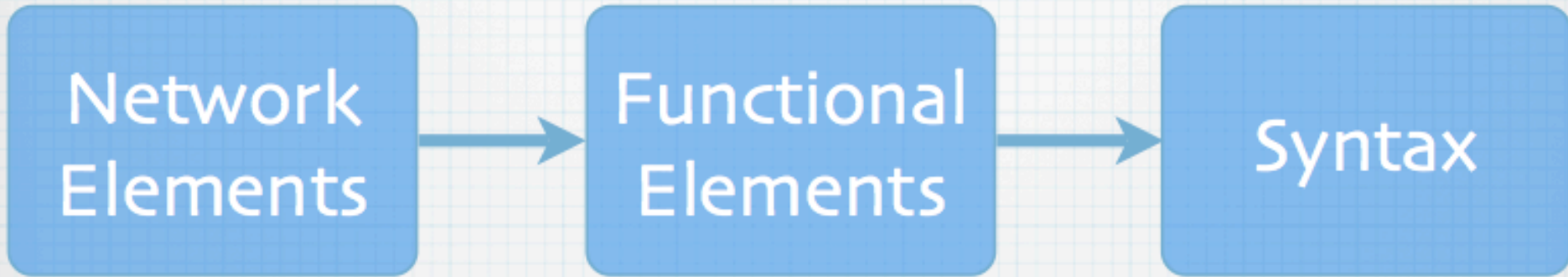

```
<ndl:Device rdf:about="#Force10">
  <ndl:hasInterface rdf:resource=
    "#Force10:te6/0"/>
</ndl:Device>
<ndl:Interface rdf:about="#Force10:te6/0">
  <rdfs:label>te6/0</rdfs:label>
  <ndl:capacity>1.25E6</ndl:capacity>
  <ndlconf:multiplex>
    <ndicap:adaptation rdf:resource=
      "#Tagged-Ethernet-In-Ethernet"/>
    <ndlconf:serverPropertyValue
      rdf:resource="#MTU-1500byte"/>
  </ndlconf:multiplex>
  <ndlconf:hasChannel>
    <ndlconf:Channel rdf:about=
      "#Force10:te6/0:vlan4">
      <ndleth:hasVlan>4</ndleth:hasVlan>
      <ndlconf:switchedTo rdf:resource=
        "#Force10:gi5/1:vlan7"/>
    </ndlconf:Channel>
  </ndlconf:hasChannel>
</ndl:Interface>
```

# Multi-layer descriptions in NDL

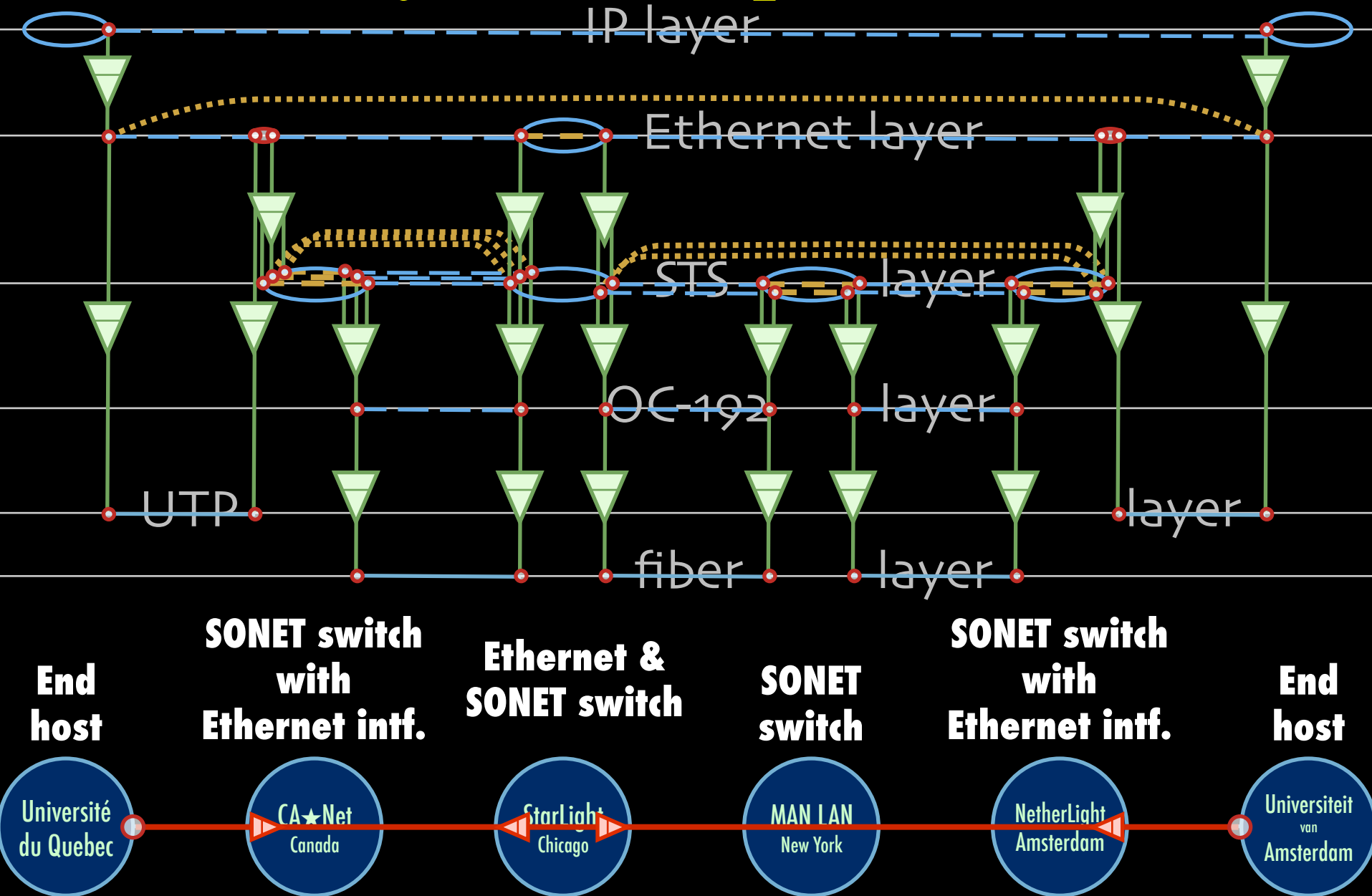

# NML OGF spec iNDL

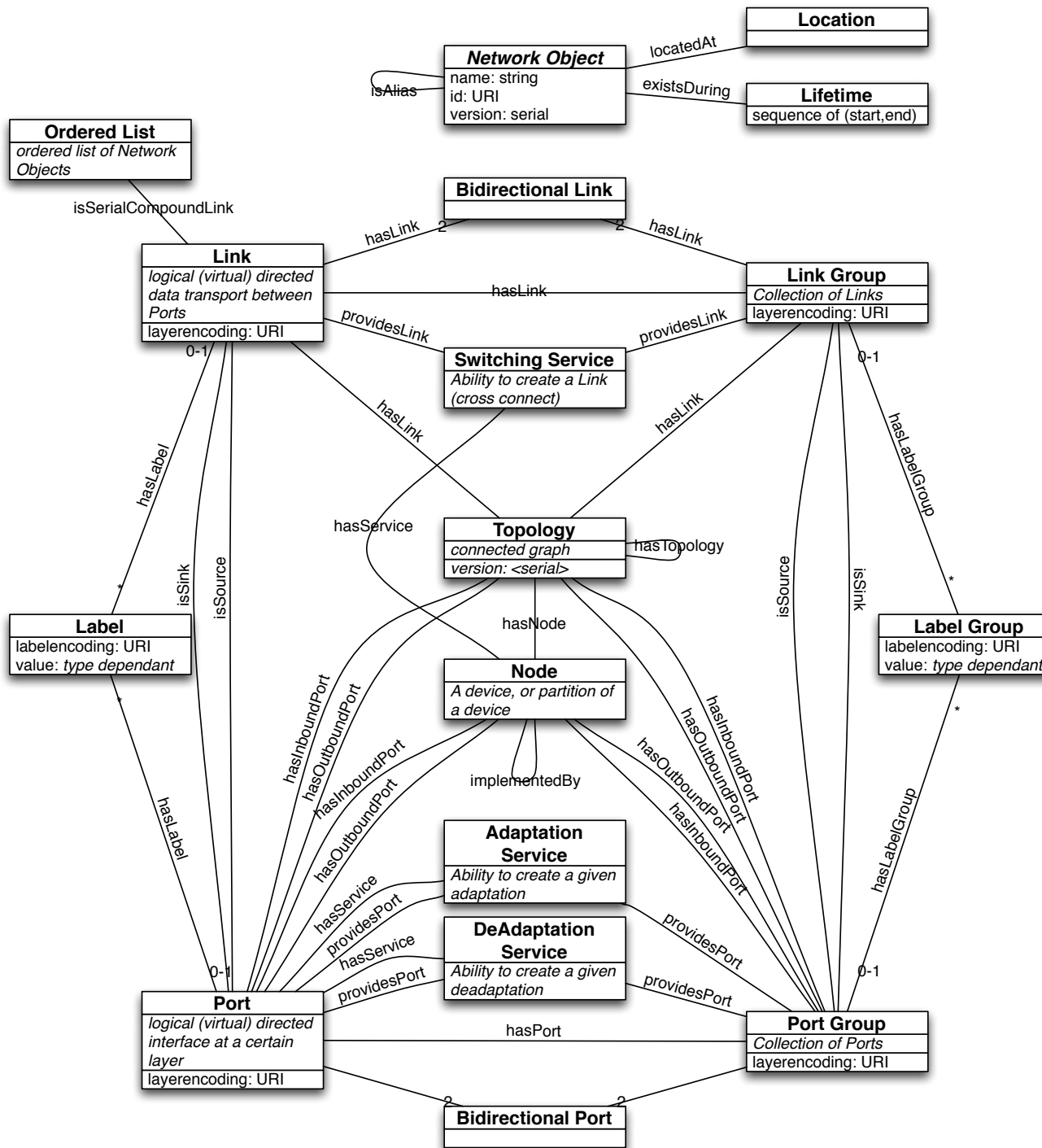

# Network Topology Description

Network topology research supporting automatic network provisioning

- Inter-domain networks
- Multiple technologies
- Based on incomplete information
- Possibly linked to other resources

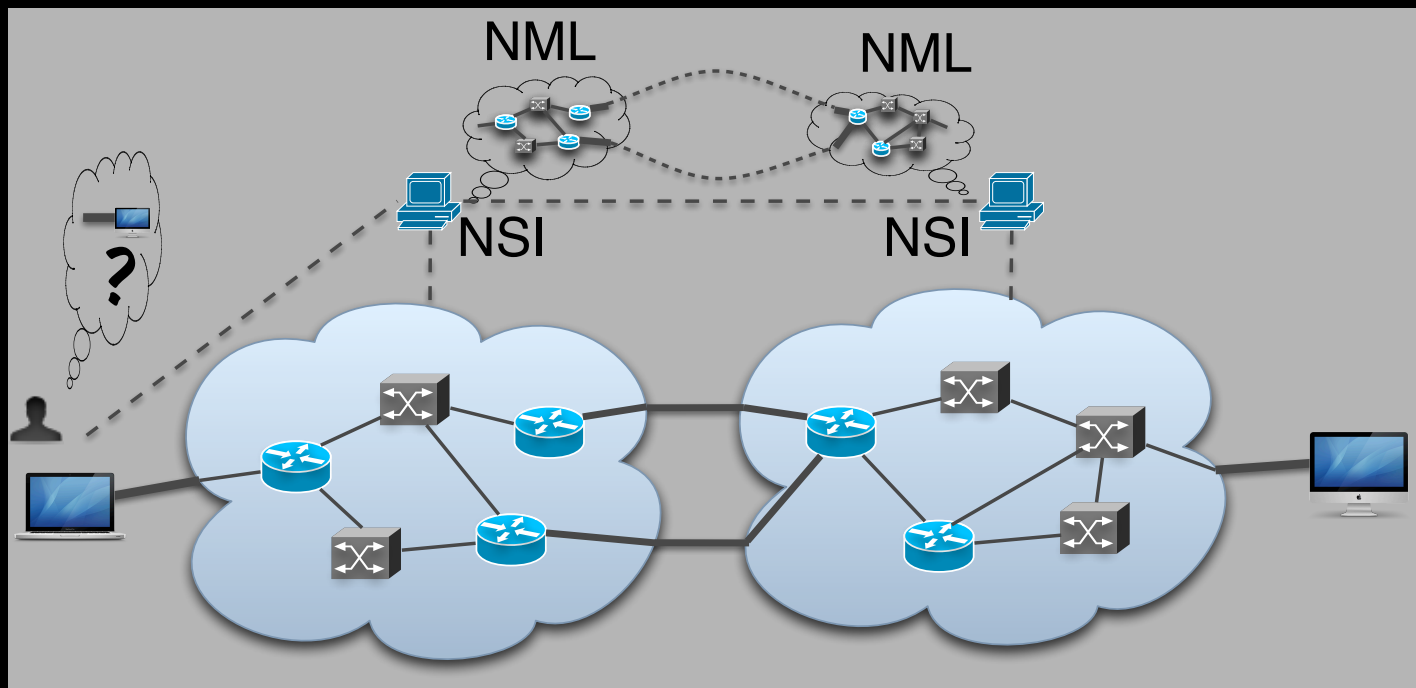



# GLIF 2013 in NML

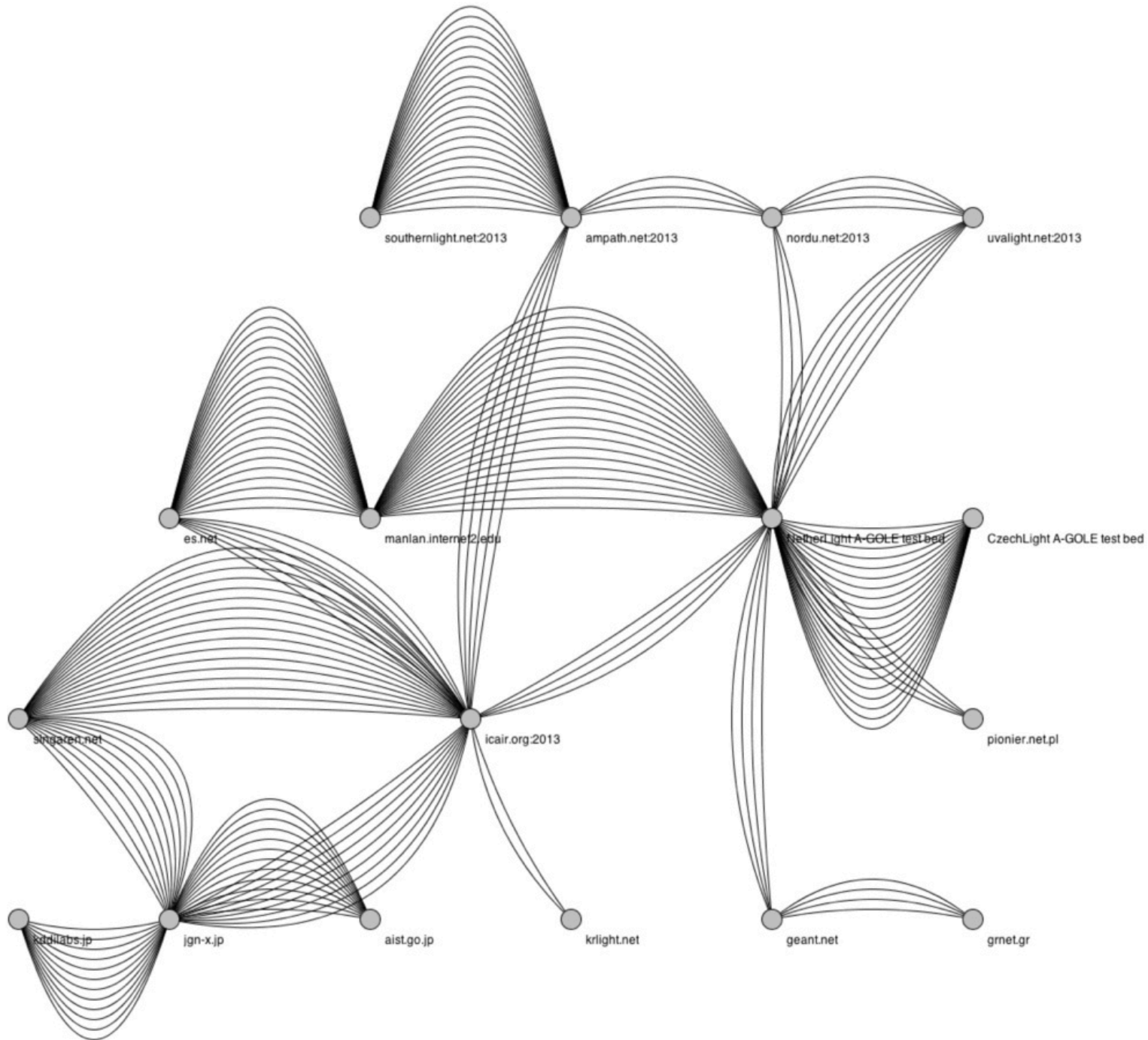

# CdL

# Applications and Networks become aware of each other!

## CineGrid Description Language

CineGrid is an initiative to facilitate the exchange, storage and display of high-quality digital media.

The CineGrid Description Language (CDL) describes CineGrid resources. Streaming, display and storage components are organized in a hierarchical way.

CDL has bindings to the NDL ontology that enables descriptions of network components and their interconnections.

With CDL we can reason on the CineGrid infrastructure and its services.

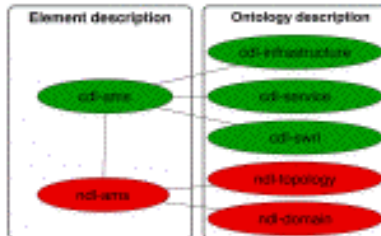

SQWRL is used to query the Ontology.

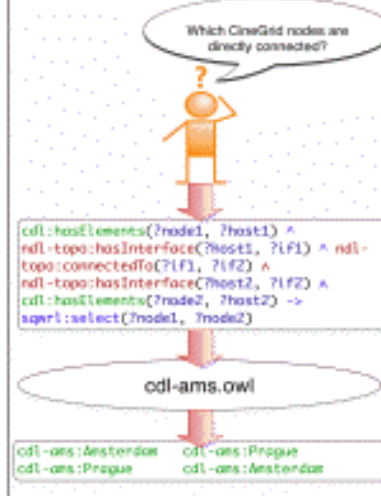

### UML representation of CDL



CDL links to NDL using the **owl:SameAs** property. CDL defines the services, NDL the network interfaces and links. The combination of the two ontologies identifies the host pairs that support matching services via existing network connections.



# Information Modeling

Define a common information model for *infrastructures* and *services*.  
Base it on Semantic Web.

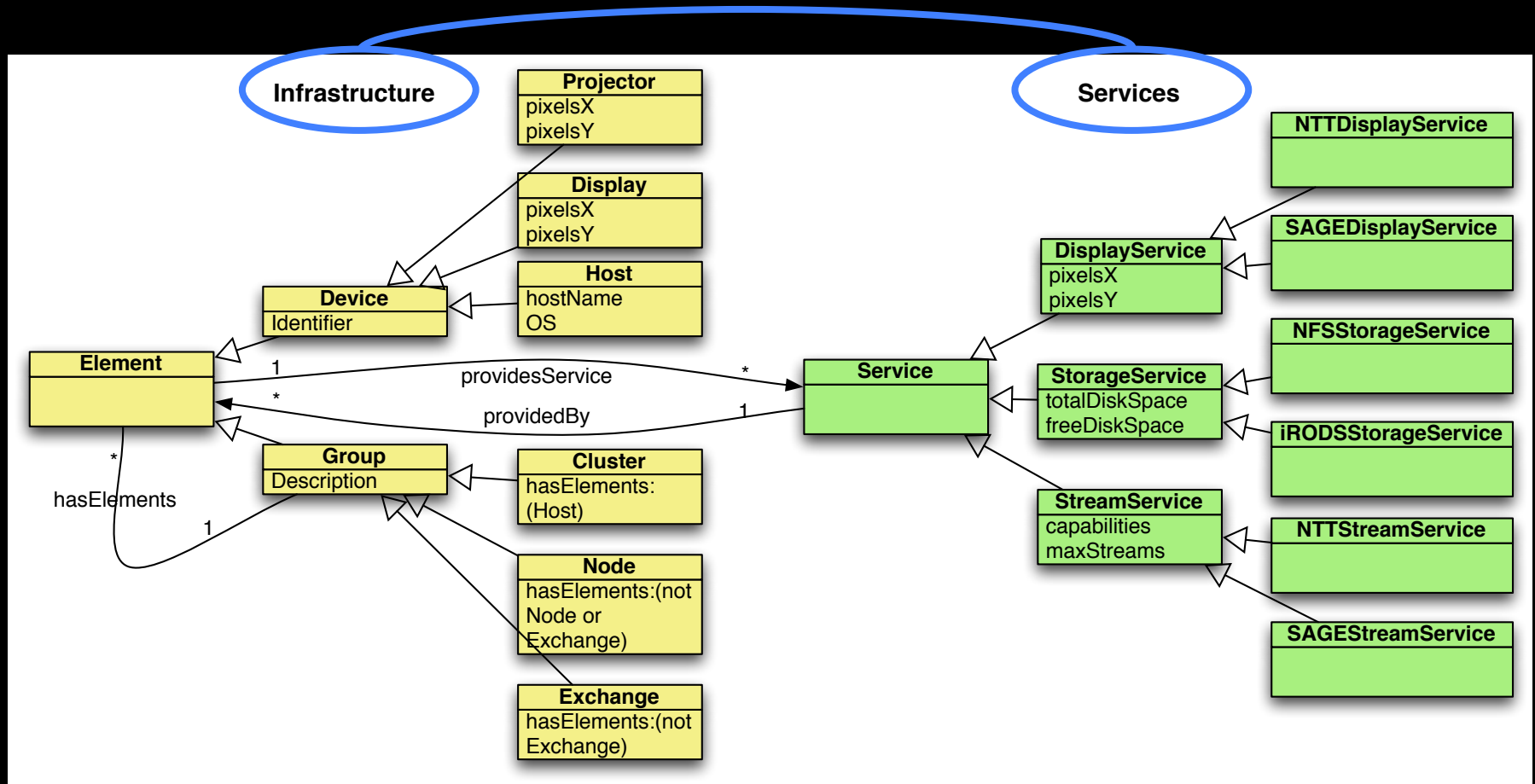

# Mission

*Can we create smart and safe data processing infrastructures that can be tailored to diverse application needs?*

- *Capacity*
  - *Bandwidth on demand, QoS, architectures, photonics, performance*
- *Capability*
  - *Programmability, virtualization, complexity, semantics, workflows*
- *Security*
  - *Anonymity, integrity of data in distributed data processing*
- ***Sustainability***
  - ***Greening infrastructure, awareness***
- *Resilience*
  - *Systems under attack, failures, disasters*



# ECO-Scheduling





# Green scheduling

## Network infrastructures

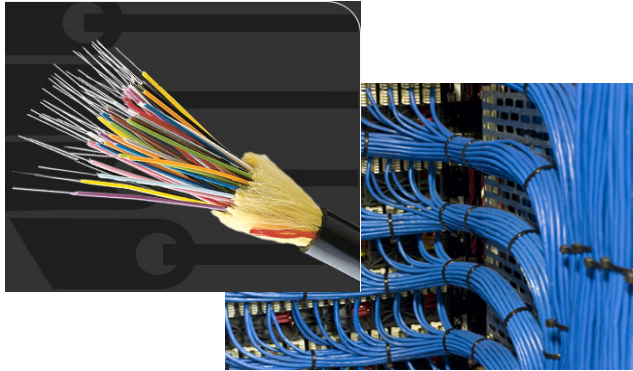

CO<sub>2</sub> footprint;  
Energy needed and lost

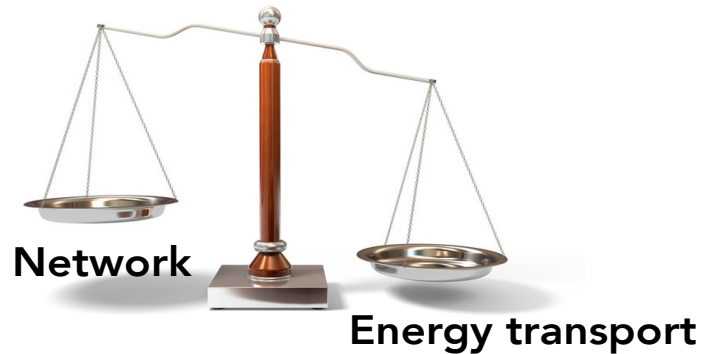

*Bits to energy*

## Green energy sources



CO<sub>2</sub> footprint;  
Energy needed and lost

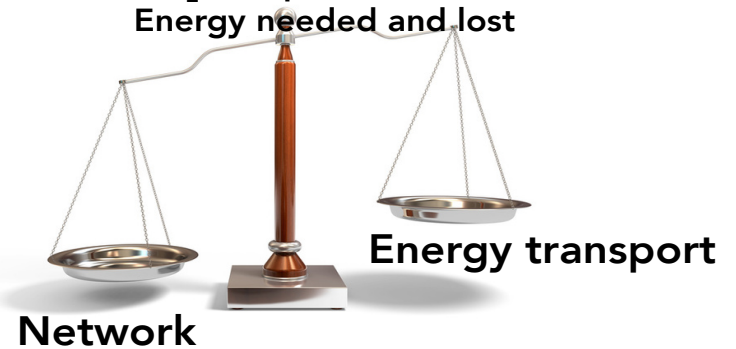

*Energy to bits*

# Energy Efficient Ethernet (802.3az)

Power savings techniques in hardware can be leveraged in architecturing communication patterns in data centra

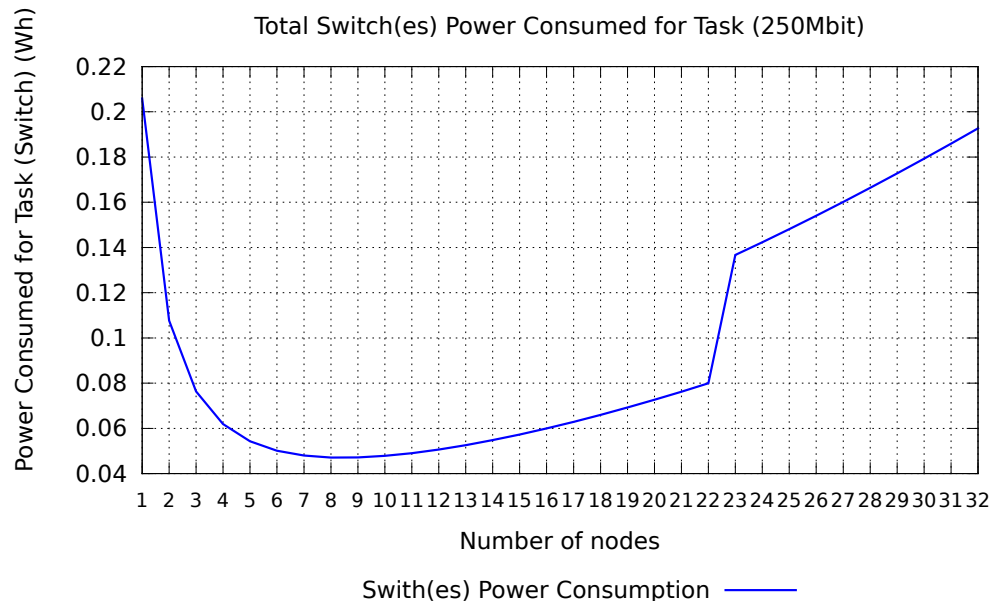
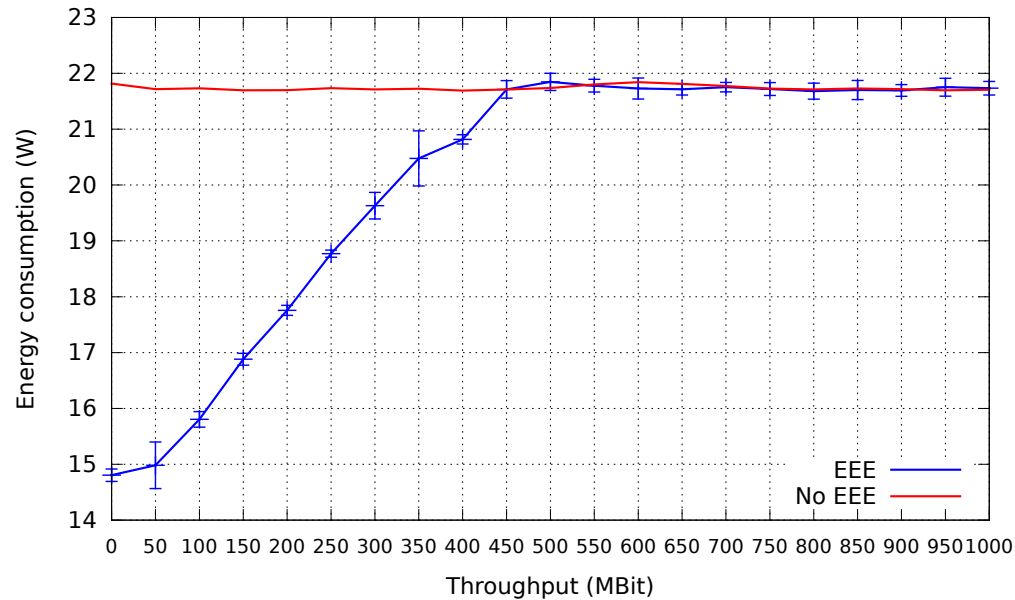
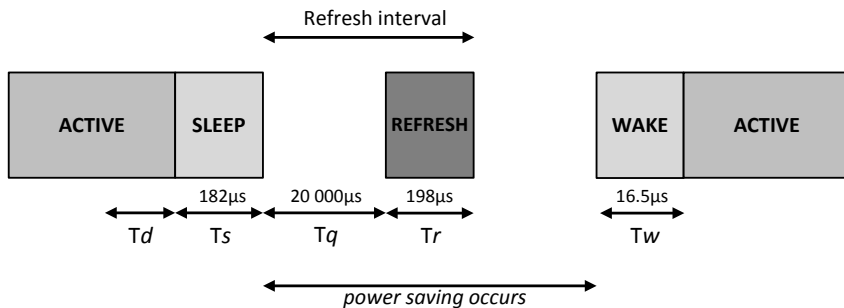

# Energy saving in clouds

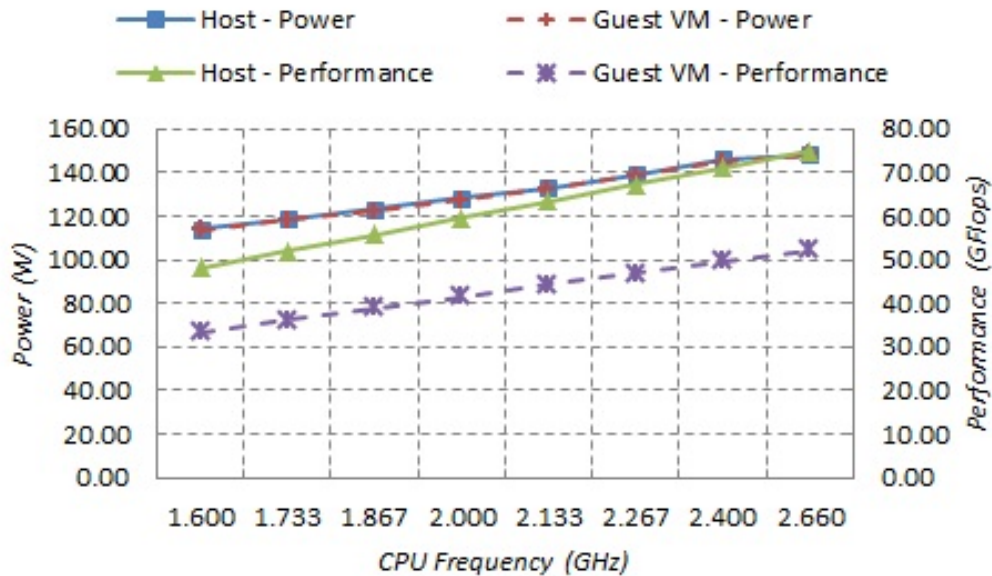

Quantifying the energy performance of VMs is the first step toward energy-aware job scheduling.

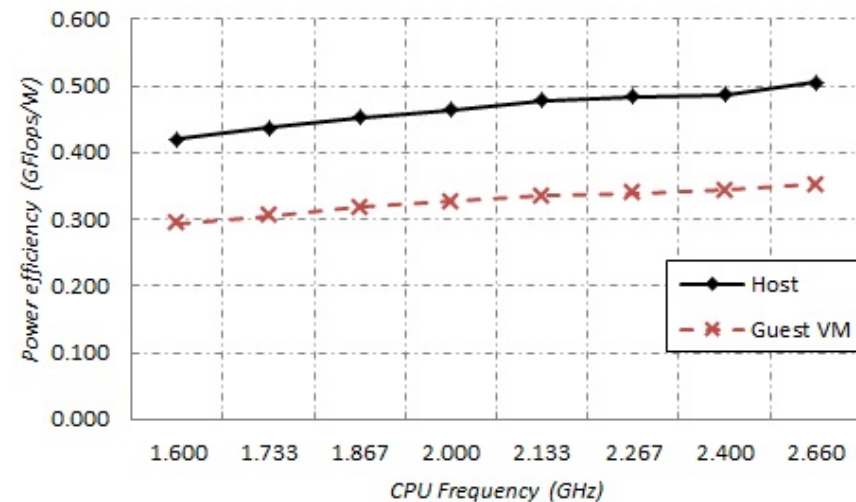
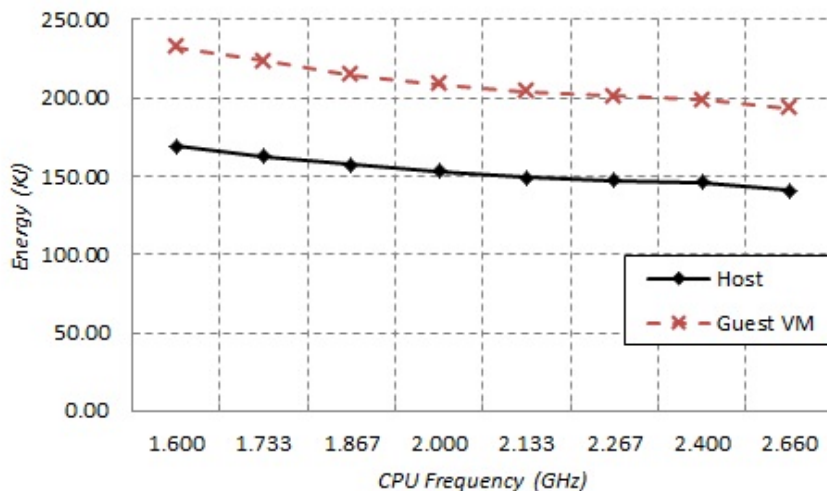

# Networks and CO2

- Take a network (ESnet, working on using SURFnet data)
- Define the traffic model running on it
- Use the energy monitoring information and energy costs data
- Compare path selection strategies : shortest, cheapest and greenest

1TB,  $\mu=0.1s$ , long flows

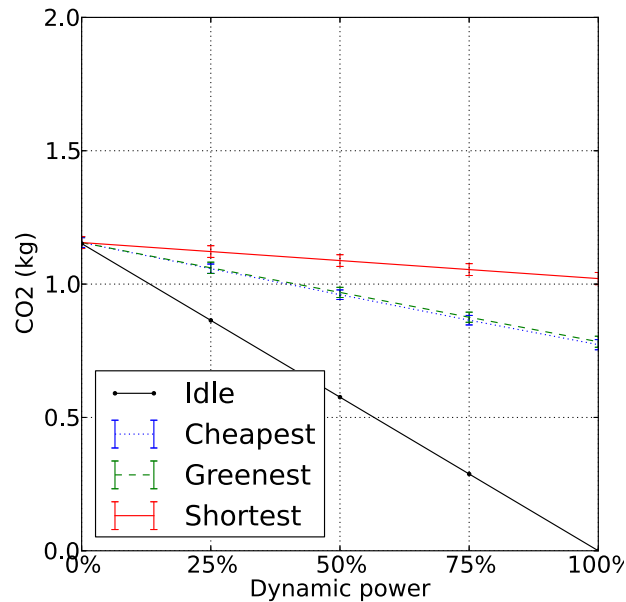

1TB,  $\mu=1s$ , long flows

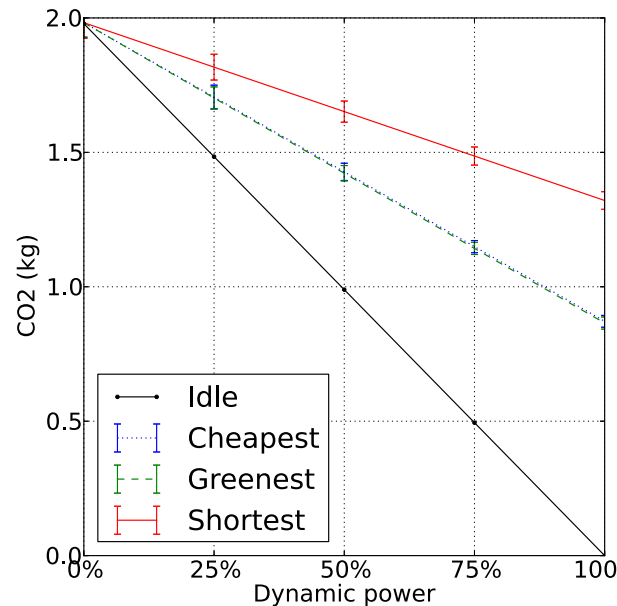

1TB,  $\mu=10s$ , long flows

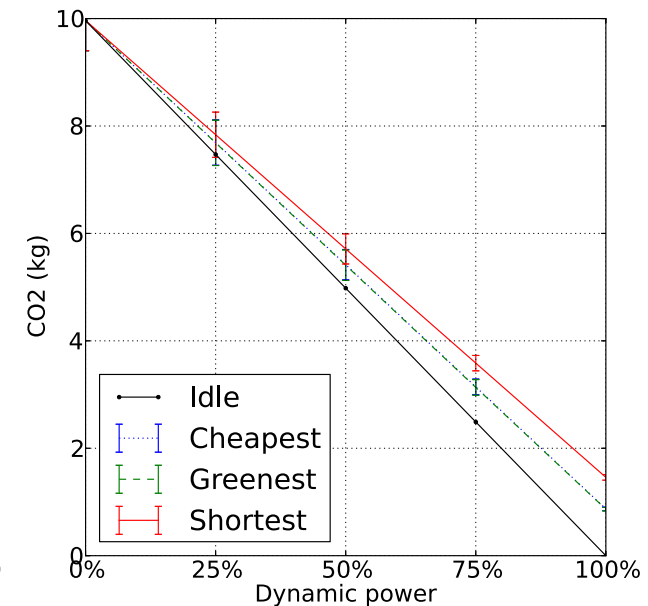

*"A motivation for carbon aware path provisioning for NRENs" (submitted to eEnergy2014)*





# Mission

*Can we create smart and safe data processing infrastructures that can be tailored to diverse application needs?*

- *Capacity*
  - *Bandwidth on demand, QoS, architectures, photonics, performance*
- ***Capability***
  - ***Programmability, virtualization, complexity, semantics, workflows***
- *Security*
  - *Anonymity, integrity of data in distributed data processing*
- *Sustainability*
  - *Greening infrastructure, awareness*
- ***Resilience***
  - ***Systems under attack, failures, disasters***



# Tera-Thinking

- What constitutes a Tb/s network?
- think back to teraflop computing!
  - MPI turns a room full of pc's in a teraflop machine
- massive parallel channels in hosts, NIC's
- TeraApps programming model supported by
  - TFlops -> MPI / Globus / Cloud
  - TBytes -> DAIS / MONETdb ...
  - TPixels -> SAGE
  - TSensors -> LOFAR, LHC, LOOKING, CineGrid, ...
  - Tbit/s -> OpenFlow & SDN
  - -> Virtualized Programmable Networks

# User Programmable Virtualized Networks allows the results of decades of computer science to handle the complexities of application specific networking.

- The network is virtualized as a collection of resources
- UPVNs enable network resources to be programmed as part of the application
- Mathematica, a powerful mathematical software system, can interact with real networks using UPVNs

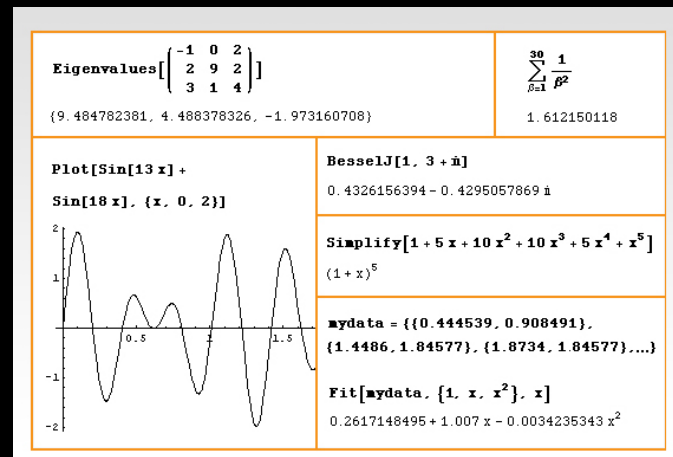
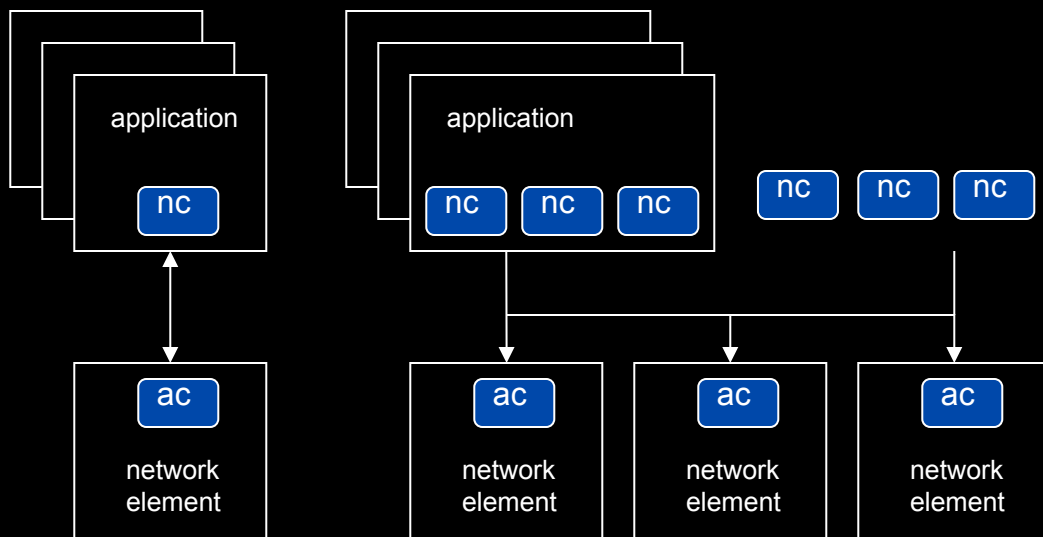



# Mathematica enables advanced graph queries, visualizations and real-time network manipulations on UPVNs

Topology matters can be dealt with algorithmically

Results can be persisted using a transaction service built in UPVN

## Initialization and BFS discovery of NEs

```
Needs["WebServices`"]
<<DiscreteMath`Combinatorica`
<<DiscreteMath`GraphPlot`
InitNetworkTopologyService["edge.ict.tno.nl"]
```

Available methods:

```
{DiscoverNetworkElements, GetLinkBandwidth, GetAllIpLinks, Remote,
NetworkTokenTransaction}
```

Global upvnverbose = True;

```
AbsoluteTiming[nes = BFSDiscover["139.63.145.94"];][[1]]
```

```
AbsoluteTiming[result = BFSDiscoverLinks["139.63.145.94", nes];][[1]]
```

```
Getting neighbours of: 139.63.145.94
Internal links: {192.168.0.1, 139.63.145.94}
(...)
```

```
Getting neighbours of: 192.168.2.3
```

```
Internal links: {192.168.2.3}
```

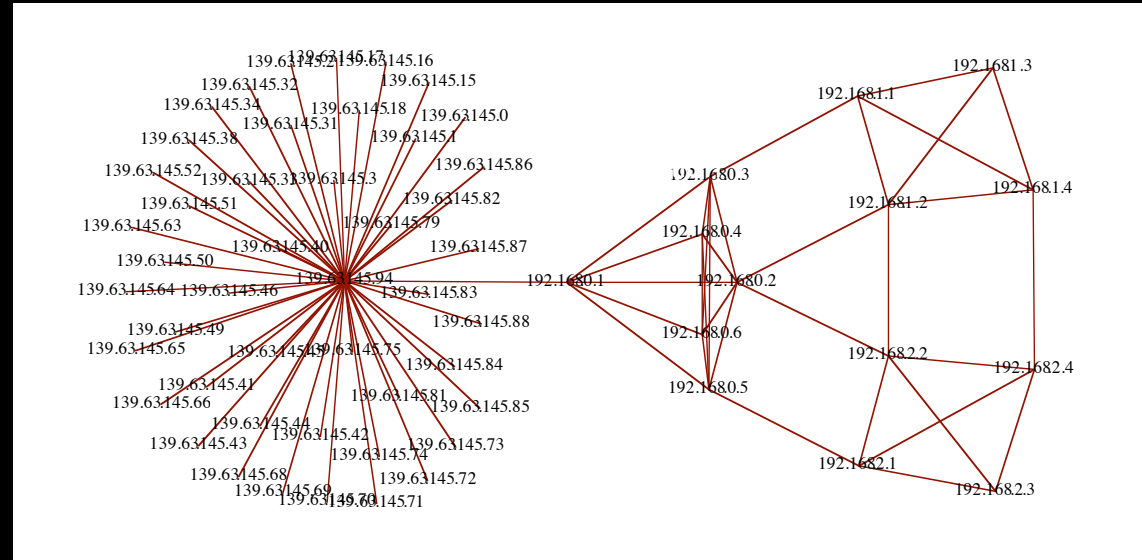

## Transaction on shortest path with tokens

```
nodePath = ConvertIndicesToNodes[
ShortestPath[
g,
Node2Index[nids, "192.168.3.4"],
Node2Index[nids, "139.63.77.49"],
nids];
Print["Path: ", nodePath];
If[NetworkTokenTransaction[nodePath, "green"] == True,
Print["Committed"], Print["Transaction failed"]];
```

```
Path:
{192.168.3.4, 192.168.3.1, 139.63.77.30, 139.63.77.49}
```

ref: Robert J. Meijer, Rudolf J. Strijkers, Leon Gommans, Cees de Laat, User Programmable Virtualized Networks, accepted for publication to the IEEE e-Science 2006 conference Amsterdam.

Network flows using real-time bandwidth measurements

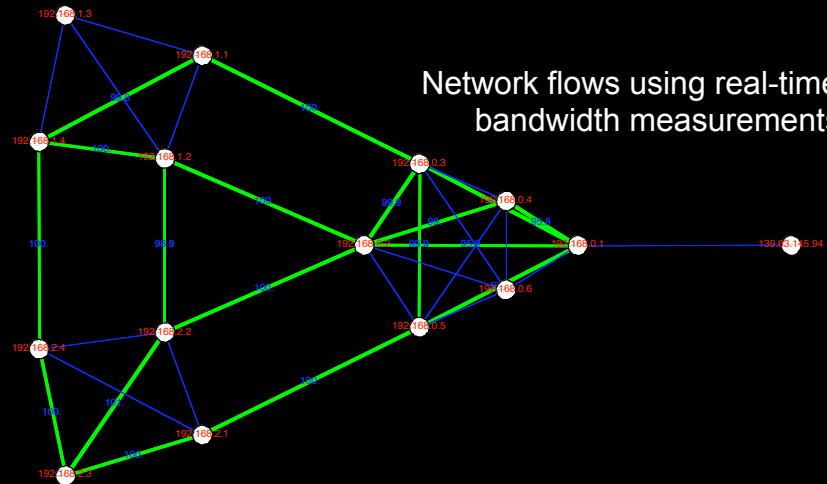

# CDN on Demand in the cloud

**Infrastructure Creator**

**Adding virtual  
infrastructure by  
dragging icons on  
to the canvas**

# Interactive programmable networks

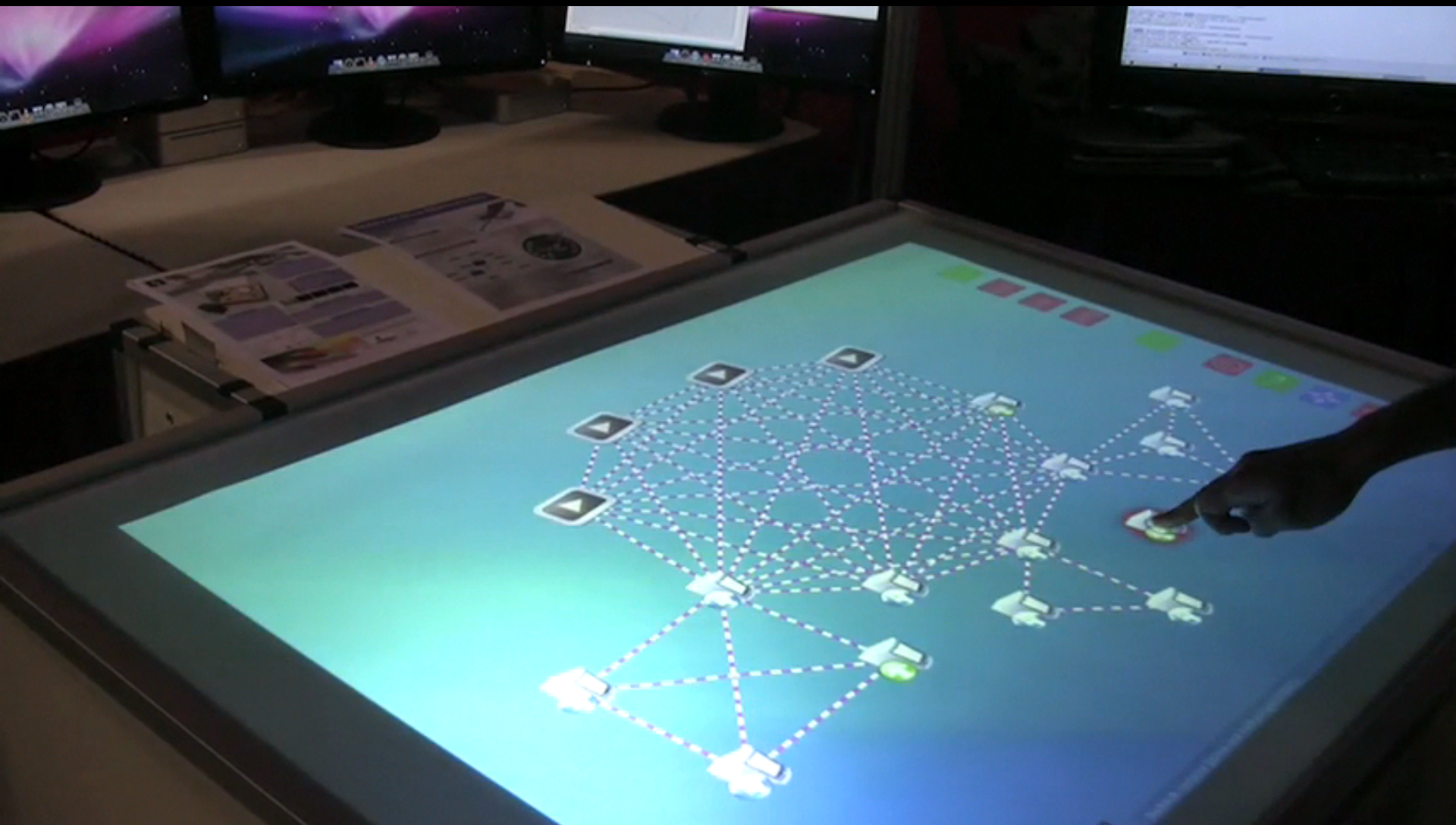



# Basic operating system loop

The screenshot displays a web browser window at localhost:4567/vi/7. The interface includes a navigation menu with options like 'netapps (provider, zone)', 'connections', and 'Mode: info', 'info edge', 'draw', 'delete node', 'delete edge'. A central graph shows nodes labeled 13124, 13127, 13128, 13125, and 13126. Below the graph, there are radio buttons for selecting different zones (e.g., eu-west-1a, us-east-1b) and a 'Create generator' section with a list of parameters. On the right, a terminal window shows code for finding articulation vertices in a graph.

```
Find all positions at  
In[1]:= Position[{1+x  
Out[1]:= {{1, 2}, {3}, {4  
Find only those down  
In[2]:= {EdgeQ[%, 1 -> 2], EdgeQ[%, 2 -> 1], EdgeQ[%, 2 -> 2]}  
Out[2]:= {True, True, False}  
Test directed edges:  
In[1]:= CycleGraph[7, DirectedEdges -> True, VertexLabels -> "Name", EdgeStyle -> Arrowheads[Medium]]  
Out[1]:= Graph[7, DirectedEdges -> True, VertexLabels -> "Name", EdgeStyle -> Arrowheads[Medium]]
```

```
Dynamic[ResolveArticulationVertices[network]]  
Dynamic[MyPlot[network]]  
Out[166]= Null  
Out[167]= {  
  {1-2-3-4-5, 1-2-3-4-5},  
  {1-2-3-4-5, 1-2-3-4-5},  
  {5-4-3-2-1, 5-4-3-2-1}  
}
```

```
network = Graph[{1 -> 2, 2 -> 3, 3 -> 1, 3 -> 4, 4 -> 5, 5 -> 6}];  
GraphPlot[network, VertexLabeling -> True, DirectedEdges -> False];
```

# Mission

*Can we create smart and safe data processing infrastructures that can be tailored to diverse application needs?*

- *Capacity*
  - *Bandwidth on demand, QoS, architectures, analytics, performance*
- *Capability*
  - *Integration, virtualization, complexity, semantics, workflows*
- *Security*
  - *Anonymity, integrity of data in distributed data processing*
- *Sustainability*
  - *Greening infrastructure, awareness*
- *Resilience*
  - *Systems under attack, failures, disasters*

**SMART**



I want to



“Show **Big Bug Bunny** in **4K** on my **Tiled Display** using **green** Infrastructure”

- **Big Bugs Bunny** can be on multiple servers on the Internet.
  - Movie may need processing / recoding to get to **4K** for **Tiled Display**.
  - Needs deterministic **Green** infrastructure for Quality of Experience.
  - Consumer / Scientist does not want to know the underlying details.
- His refrigerator also just works!

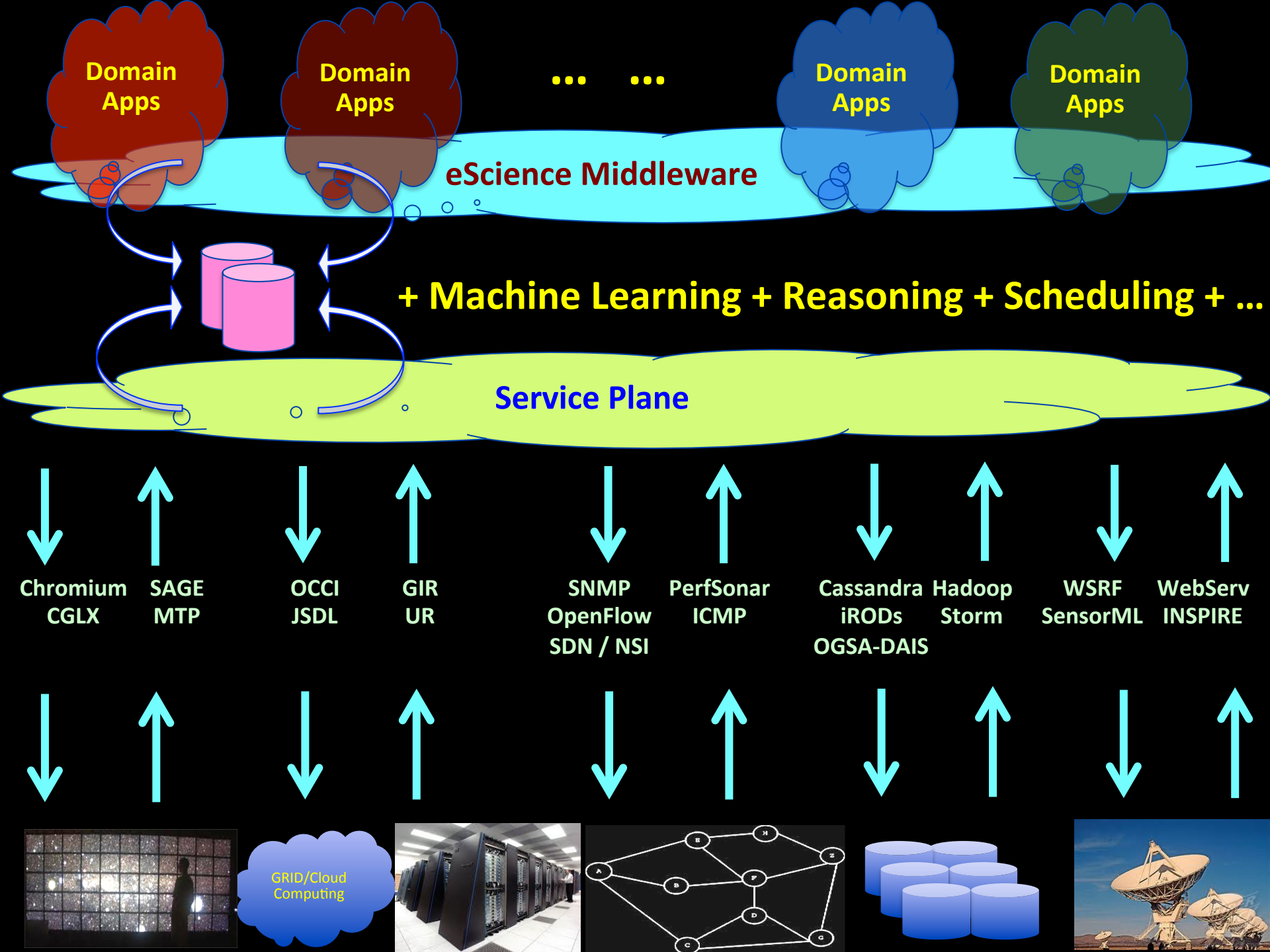



# Layers

Doing Science

ICT to enable Science

Wis  
dom

Ta  
da

Knowledge  
to act

Schedulers  
to act

Information

OWL

Data

XML, RDF, rSpec,  
text, Java based, etc.

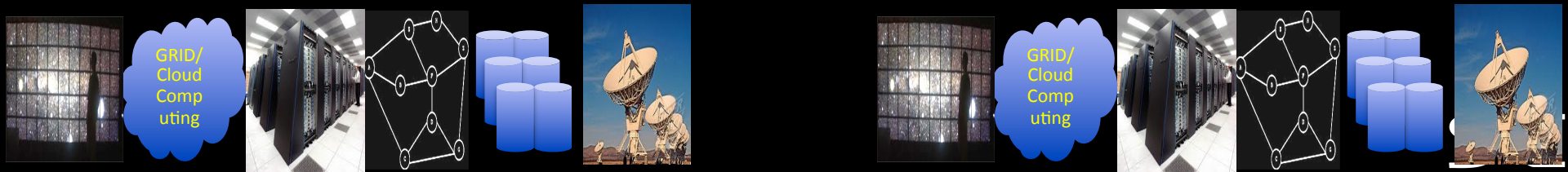

GRID/  
Cloud  
Comp  
uting

GRID/  
Cloud  
Comp  
uting

# The Big Data Challenge

Doing Science

ICT to enable Science

Wisdom

Tada

Knowledge

Schedulers

MAGIC DATA CARPET

curation – description – security – policy – integrity - storage

Information

IT

Data



XML, RDF, rSpec,  
text, Java based, etc.

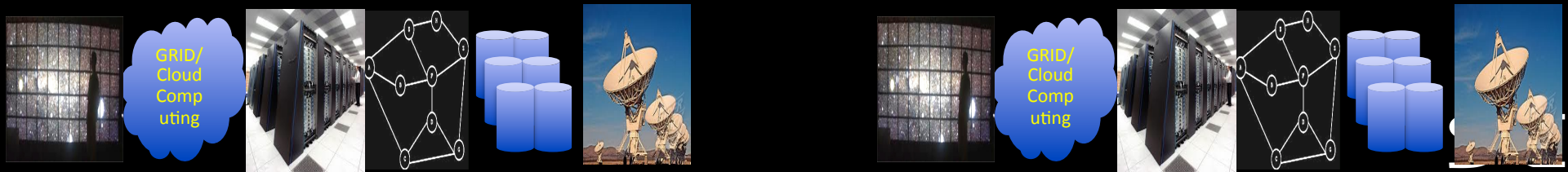

# TimeLine

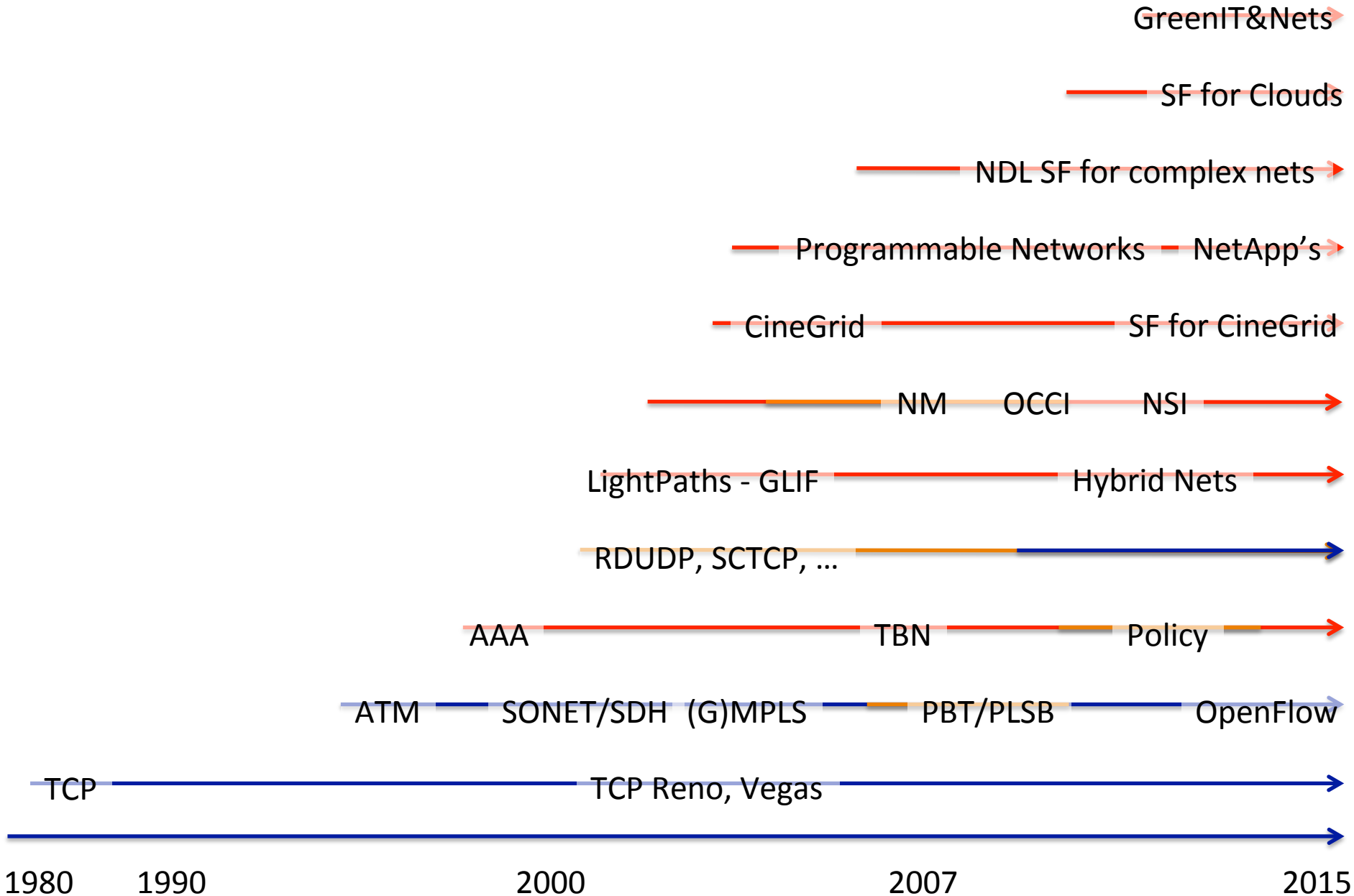

# TimeLine

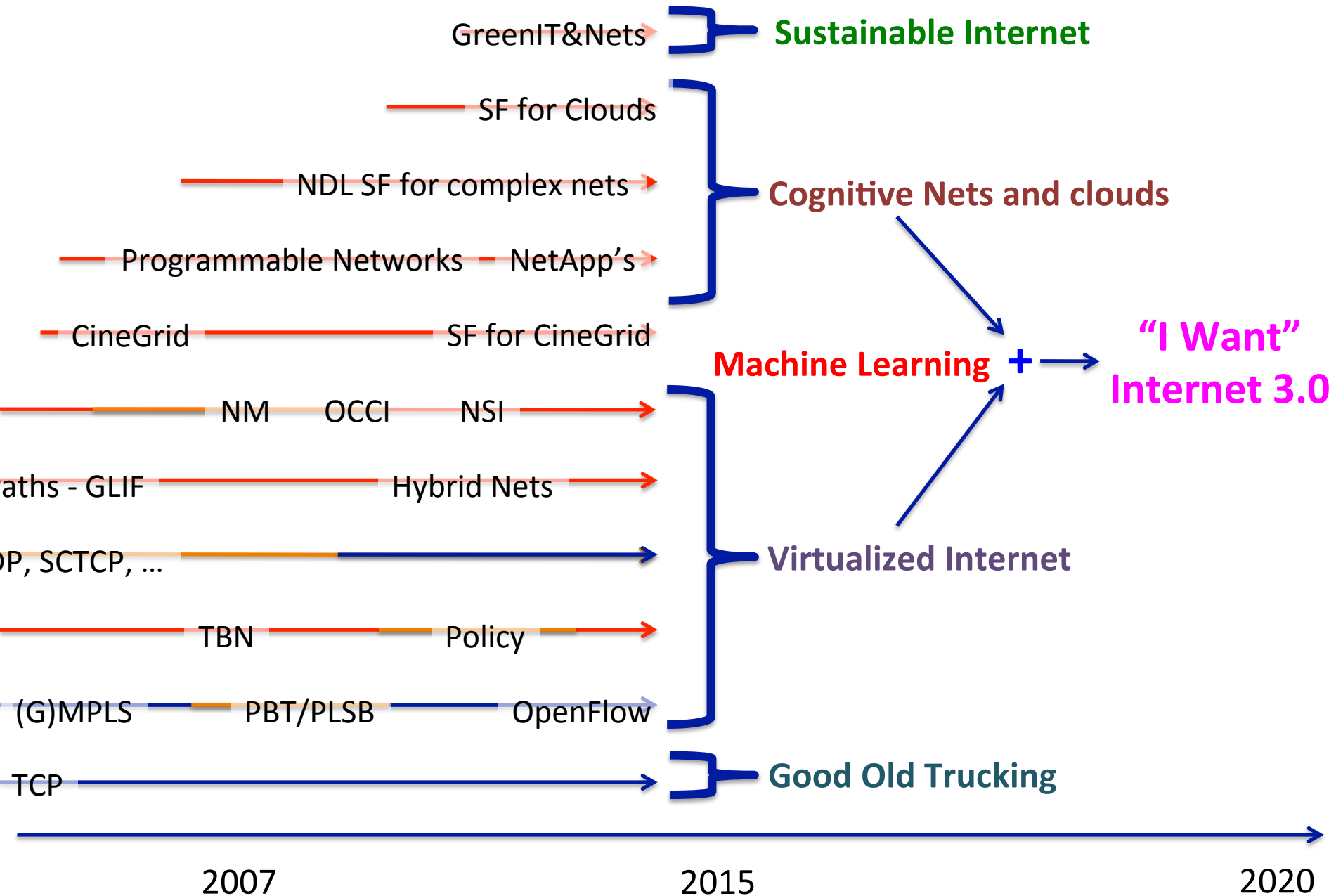



# TimeLine

• Sustainable Internet

• Cognitive Nets and clouds

• Machine Learning +

• Virtualized Internet

• Good Old Trucking

“I Want”  
Internet 3.0



I  
retire

2020

2040

# Mission

*Can we create smart and safe data processing infrastructure that can be tailored to diverse application needs?*

- *Bandwidth, demand, QoS, architectures, protocols, performance*
- *Scalability*
  - *Programmability, virtualization, complexity, semantics, workflows*
- *Security*
  - *Anonymity, integrity of data in distributed data processing*
- *Sustainability*
  - *Greening infrastructure, energy efficiency*
- *Resilience*
  - *Systems under attack, failures, disasters*

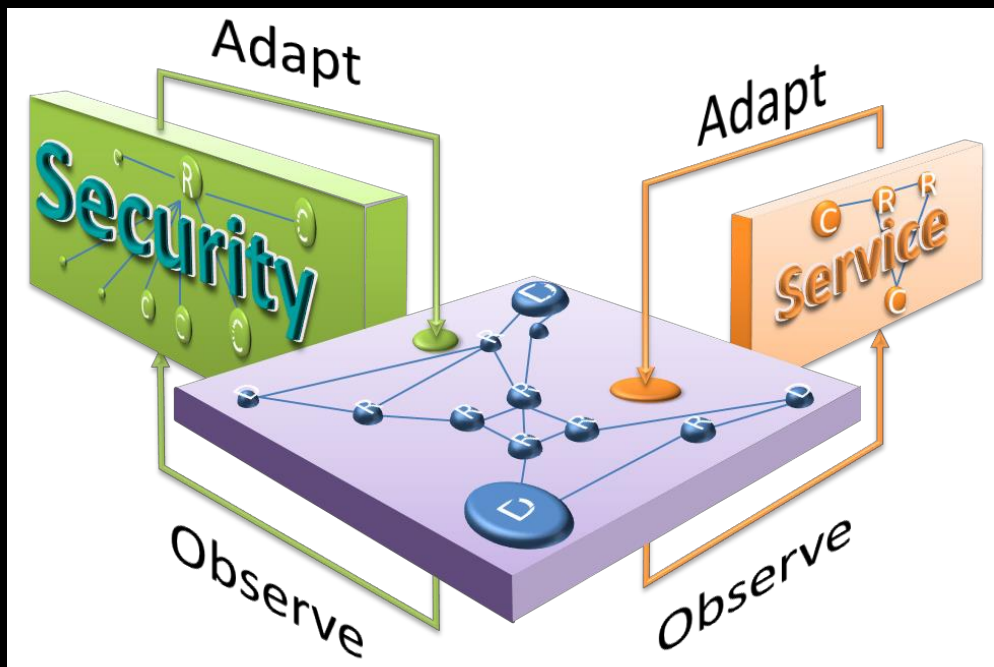

# SARNET

Cyber Security program

PI: CdL

Co-Pi's: RM, LG, RW

- 400 + 285 + 300 kEuro:
- 3 PhD's
- Programming and
- Engineering manpower

- Network virtualizations and SDN
- Reasoning
- Risk evaluation
- Trust groups
- Execute response & adaptation



[delaat.net/sarnet](http://delaat.net/sarnet)

# Challenges in system level environmental sciences



**Quality challenge:**  
Quality control for large quantity and nearly real time sensor data

**Collaboration challenge** in documenting data processing workflows and sharing among communities.

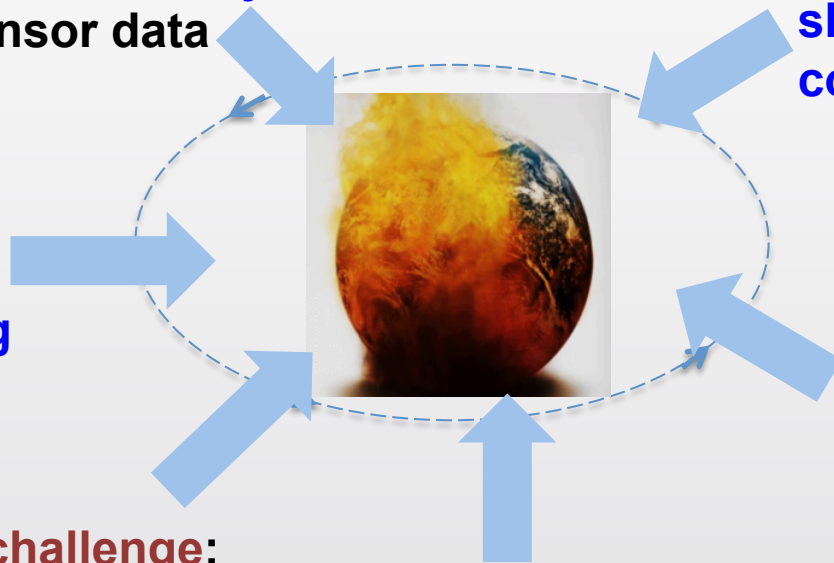

**Execution challenge** in executing applications on distributed computing infrastructures



**Identification/ Citation/ challenge** Identifying and citing data objects, and in publishing data

**Access challenge:** accessing data from different sources

**Processing challenge** in combining different data processing models

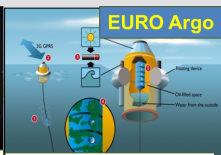
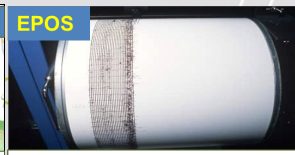
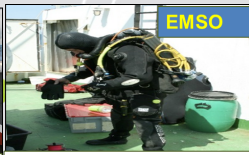
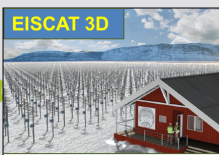



## Objectives:

- 1) **Analysis and design interoperable** ICT solutions for prioritized problems current RIs are facing
- 2) **Develop** the solutions together with the RIs
- 3) **Validate** the solutions and **deploy** them on e-Infrastructures for future operation

UvA: 840 kEuro

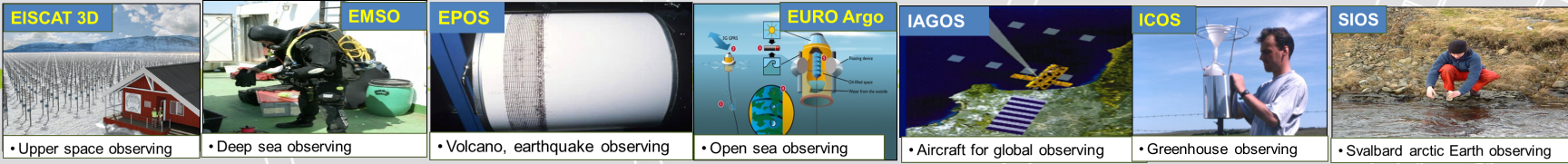
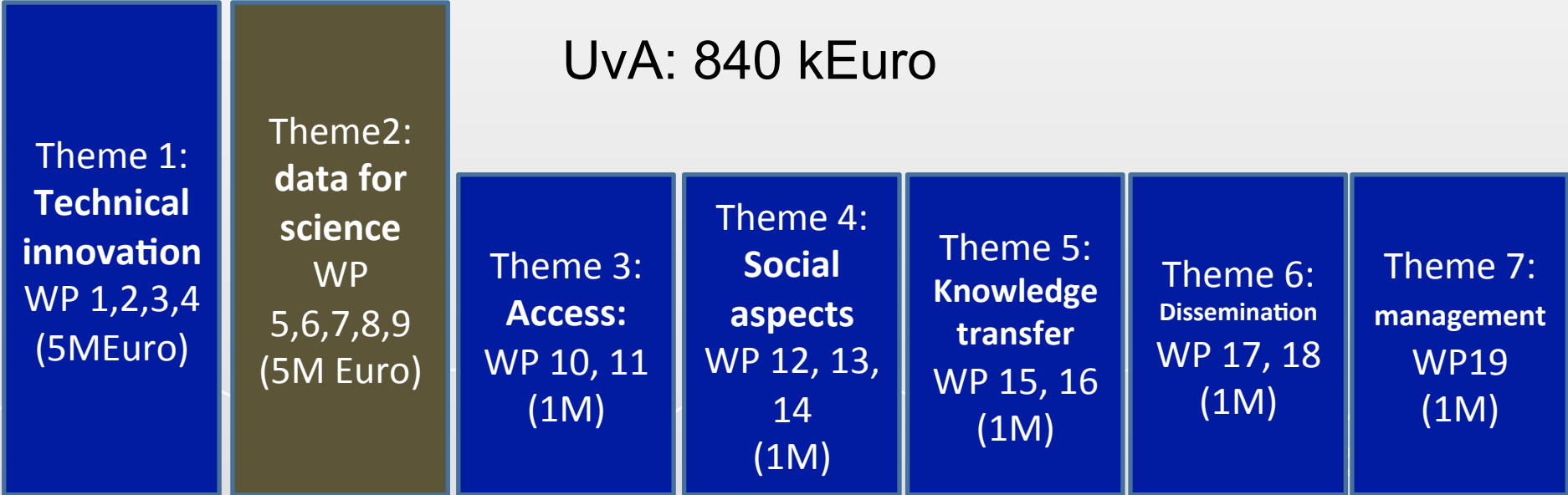



ENVRI+

# Principles for the solutions

## User point of view

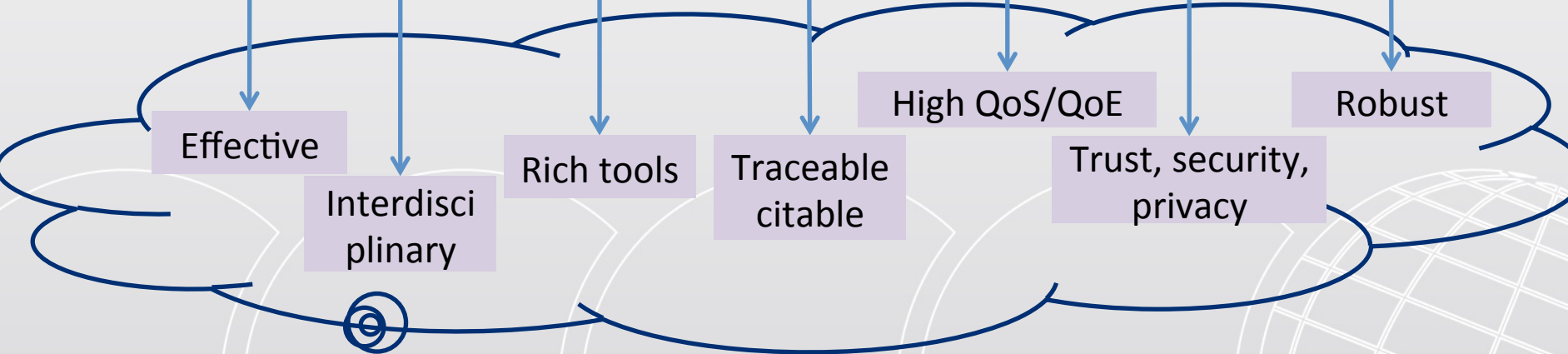
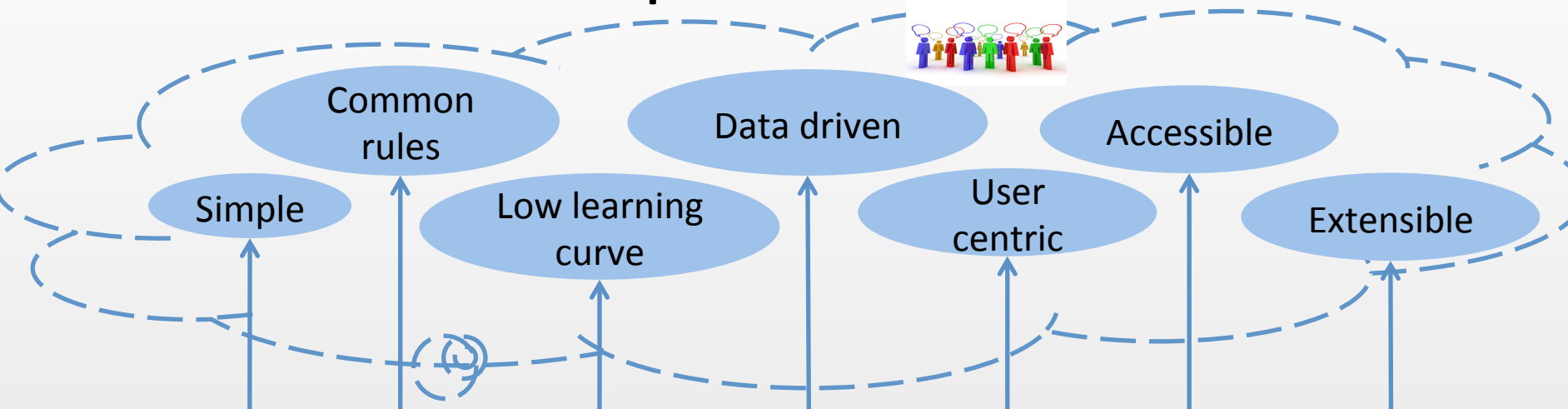

## Supporting environments point of view



Kick-off meeting, 10-Feb-2015, Amsterdam, the Netherlands



EU H2020-  
ICT-2014

# SWITCH

Software **W**orkbench for **I**nteractive, **T**ime **C**ritical and **H**ighly self-adaptive Cloud applications

PI - Dr. Zhiming Zhao

PI - Prof. Cees de Laat

System and network engineering

University of Amsterdam

3 MEuro – 780 kEuro



UNIVERSITEIT  
VAN AMSTERDAM

Wellness Telecom



CARDIFF  
UNIVERSITY



Univerza v Ljubljani



MOG  
enabling media challenges

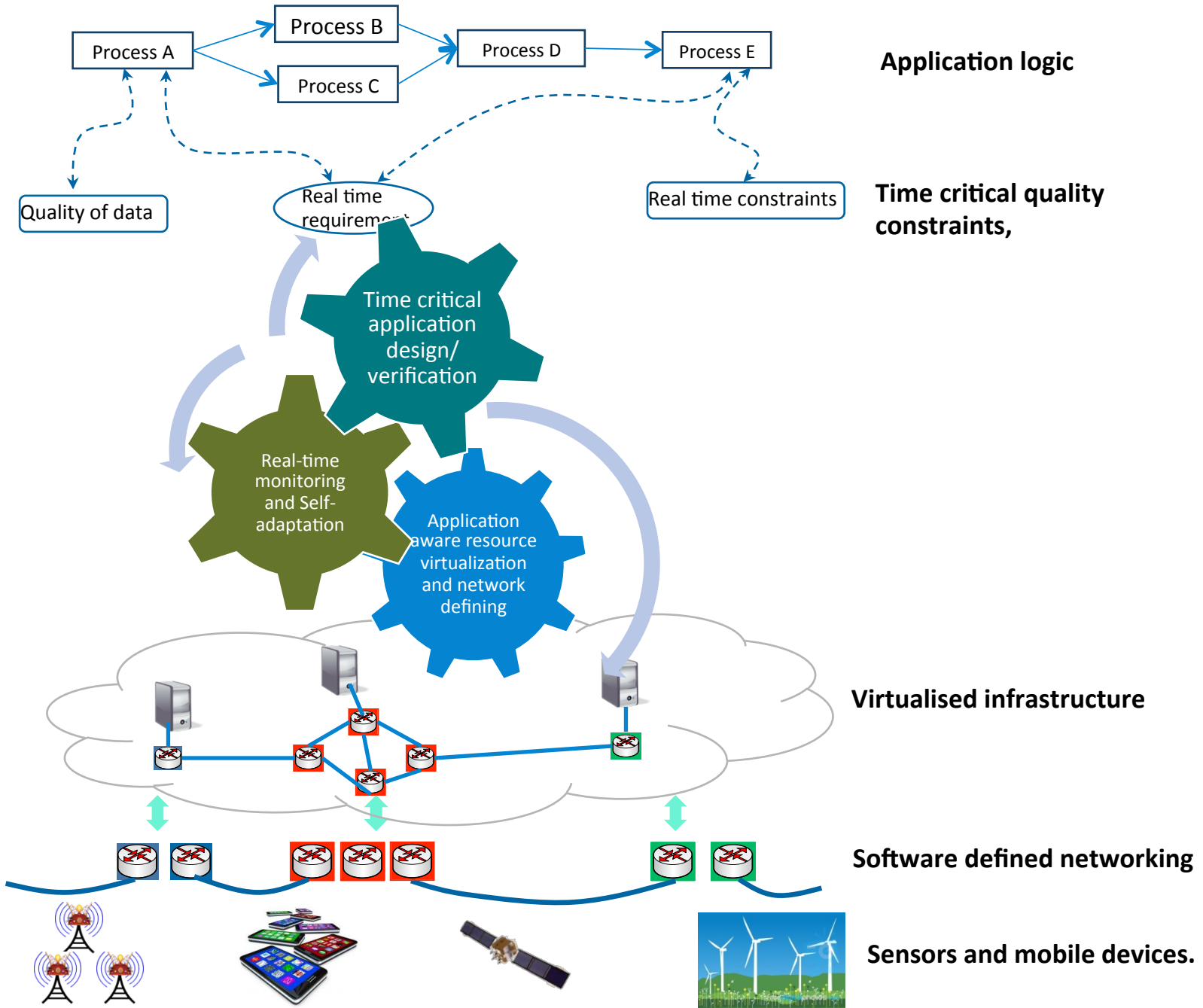



# Other Grants

- CYCLONE – Intercloud – 450 kEuro
  - Yuri Demchenko
- Information complexity – 500 kEuro
  - Pieter Adriaans
- iDapt – DSL extra functional behavior 500 kEuro
  - Andy Pimentel, Rafael Poss
- Extra - Software Defined Computing ☺ - 500 kEuro
  - Ana Varbanescu

# The constant factor in our field is Change!

The 50 years it took Physicists to find one particle, the Higgs,  
we came from:

Assembler, Fortran, COBOL, VM, RSX11, Unix, c, Pascal,  
SmallTalk, DECnet, VMS, TCP/IP, c++, Internet, WWW,  
ATM, Semantic Web, Photonic networks, Google, Grid,  
Phyton, FaceBook, Twitter, Cloud, SDN, Data<sup>3</sup>, App's

to:

DDOS attacks destroying Banks and BitCoins!

Conclusion:

Need for Safe, Smart, Resilient Sustainable Infrastructure.

# Questions?

Arie Taal  
Paola Grosso Ana Oprescu  
Cees de Laat Marc Makkes Ralph Koning  
Bas Terwijn Leon Gommans Fahimeh Alizadeh  
Pieter Adriaans Cosmin Dumitru Karst Koymans  
Yuri Demchenko Rob Meijer Karel van der Veldt  
Rudolf Strijkers Miroslav Zivkovic Reggie Cushing  
Naod Duga Jebessa Spiros Koulouzis Hao Zhu Jan Sipke van der Veen  
Jaap van Ginkel Guido van 't Noordende Sander Klous  
Mikolaj Baranowski Steven de Rooij Jeroen van der Ham  
Ngo Tong Canh Souley Madougou Paul Klint  
Adianto Wibisono Magiel Bruntink  
Zhiming Zhao Anna Varbanescu Marijke Kaat  
Niels Sijm Hans Dijkman Gerben de Vries  
Adam Belloum Arno Bakker Marian Bubak  
Daniel Romao Erik-Jan Bos  
Peter Bloem

<http://delaat.net>

<http://sne.science.uva.nl>

<http://www.os3.nl/>

<http://sne.science.uva.nl/openlab/>

<http://pire.opensciencedatacloud.org>

<http://staff.science.uva.nl/~delaat/pire/>

<https://rd-alliance.org>

<http://envri.eu>

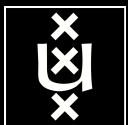

Data Science  
Research Center  
Amsterdam

Supported by:

